

Distributed by  
**Raymarine**

Any reference to Raytheon or RTN in this manual should be interpreted as Raymarine. The names Raytheon and RTN are owned by the Raytheon Company.

# **ST7000 Plus Autopilot Control Unit**

## Owner's Handbook

Document number: 81118\_1  
Date: 20 January 1999



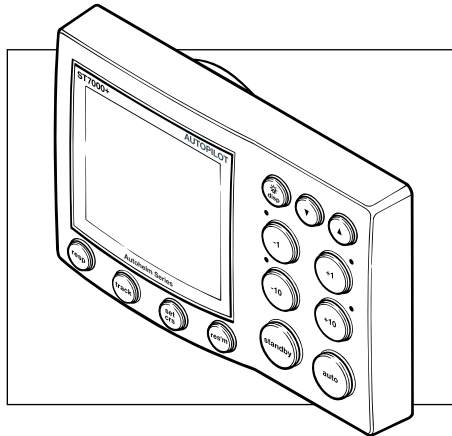

Raytheon Electronics, as part of its commitment to continuous improvement and updating, reserve the right to make changes, without prior notice, to the equipment, equipment specifications, and the instructions contained within this handbook.

To the best of our knowledge, the information contained within this handbook was correct as it went to press.

A great deal of care has been taken to ensure that this handbook is as accurate as possible. However, liability cannot be accepted for inaccuracies or omissions.

Autohelm and SeaTalk are registered trademarks of the Raytheon Marine Company

WindTrim, AutoTack, AutoSeastate, AutoAdapt, AutoRelease and AutoTrim are trademarks of Raytheon Marine Company

Copyright © Raytheon Marine Company 1998



# Contents

- Preface ..... xi**
  - How this Handbook is Organised ..... xi
  - Warranty ..... xi
  - Safety Information ..... xii
  - EMC Conformance ..... xiii
  
- Chapter 1: Introduction ..... 1**
  - 1.1 Overview ..... 1
  - 1.2 Specification ..... 2
  
- Chapter 2: Basic Operation ..... 3**
  - 2.1 Key Functions ..... 3
  - 2.2 Display Layout ..... 4
    - Bar Graph ..... 4
    - Distance Units ..... 5
  - 2.3 Start Up Conditions ..... 5
  - 2.4 Using Auto Mode ..... 5
    - Safety ..... 5
    - Engaging the Autopilot ..... 5
    - Return to Hand Steering ..... 6
    - Changing Course ..... 6
    - Dodging Obstacles in Auto Mode ..... 7
    - Returning to the Previous Locked Heading ..... 8
    - Automatic Tack ..... 9
      - AutoTack to Starboard ..... 9
      - AutoTack to Port ..... 9

Off Course Alarm .....	10
Operating Hints .....	10
Making Major Course Changes .....	10
Course Changes Under Autopilot Control .....	10
Sailboats in Gusty Conditions .....	11
2.5 Using Manual Mode .....	11
2.6 Setting Up Backlighting and Contrast .....	12
Backlighting .....	12
Contrast .....	13
2.7 Data Pages .....	13
Waypoint names .....	14
2.8 Remotely Controlling ST60 and ST80 Instruments ..	15
<b>Chapter 3: Advanced Operation .....</b>	<b>17</b>
3.1 Operating in Track Mode .....	17
Initiating Track Mode .....	17
Automatic Acquisition .....	18
Manual Acquisition .....	19
Cross Track Error .....	20
Tidal Stream Compensation .....	21
Waypoint Arrival and Advance .....	21
Arrival .....	21
Skipping a Waypoint .....	22
Advance .....	22
Dodges .....	22
Initiating a Dodge Manoeuvre .....	22
Cancelling a Dodge Manoeuvre .....	22

---

Safety .....	23
Position Confirmation at the Start of a Passage ..	23
Verifying Computed Positions .....	23
Plot Frequency .....	23
Setting Waypoints .....	23
General .....	23
3.2 Operating in Wind Mode (WindTrim) .....	24
Selecting Wind Mode .....	24
Adjusting the Locked Wind Angle .....	25
Returning to the Previous Apparent Wind Angle (LAST WIND) .....	25
Dodges .....	26
Wind Shift Alarm .....	26
Using AutoTack in Wind Mode .....	26
Operating Hints .....	27
3.3 Adjusting Autopilot Performance .....	28
Changing the Response Level .....	28
Changing the Rudder Gain .....	29
3.4 Alarms .....	29
SeaTalk Failure .....	29
No Link .....	29
Off Course .....	30
Wind Shift .....	30
Large Cross Track Error .....	30
Drive Stopped .....	30
Data Not Received .....	30



Waypoint Advance .....	31
Low Battery .....	31
Watch Alarm .....	32
Route Completed .....	32
AutoRelease .....	32
Shallow .....	33
Man Overboard (MOB) .....	33
<b>Chapter 4: Customising the System .....</b>	<b>35</b>
Important .....	35
4.1 User Setup .....	35
Pilot Type .....	37
Compass Deviation Correction .....	37
Deviation Display .....	37
Heading Alignment .....	37
Heading Mode) .....	38
Bar Selection .....	38
Rudder Calibration .....	38
Popup Timeout .....	39
Auto Tack .....	39
Data Pages .....	39
Software Version Number .....	41
4.2 Dealer Setup: Type 100/300 Course Computer .....	41
Recommended Settings .....	42
Pilot Type .....	42
Calibration Lock .....	43
Rudder Gain .....	43

---

Rate Level .....	43
Rudder Offset .....	44
Rudder Limit .....	44
Turn Limit .....	44
Cruise Speed .....	45
Off Course Alarm .....	45
AutoTrim .....	46
Power Steer .....	46
Drive Type .....	47
Rudder Damping .....	47
Variation .....	48
AutoAdapt .....	48
Latitude .....	49
Wind Trim .....	49
AutoRelease .....	49
Response .....	49
Recording Calibration Settings .....	50
4.3 Setting Up For ST60 and ST80 Remote Control .....	50
Instrument Grouping .....	51
Setting Up Groups .....	51
Grouping Standard Instruments .....	52
Grouping Maxiview Instruments .....	54
<b>Chapter 5: Installation .....</b>	<b>57</b>
5.1 Planning the Installation .....	57
EMC Installation Guidelines .....	57
Cabling .....	58

5.2 Instrument .....	58
Siting .....	58
Mounting Procedure .....	59
Power .....	60
Connections to the SeaTalk Bus .....	60
SeaTalk Cables .....	60
Cable Types .....	60
Typical SeaTalk Cabling .....	61
5.3 NMEA Interface .....	61
Cabling .....	61
NMEA Cable Connectors .....	62
NMEA Data .....	62
Transmission of NMEA Data on SeaTalk .....	63
5.4 Functional Test (Repeater Unit) .....	63
Switch On .....	64
Navigation Interface (GPS, Decca, Loran) .....	64
SeaTalk Interface .....	65
<b>Chapter 6: Post Installation Procedures .....</b>	<b>67</b>
6.1 Functional Test and Initial Calibration .....	67
Switch On .....	67
Initial Calibration .....	67
Operating Sense .....	68
Navigation Interface (GPS, Decca, Loran) .....	68
Wind Transducer Interface .....	69
SeaTalk Interface .....	69
EMC Conformance .....	70

- 6.2 Initial Sea Trial ..... 70
  - Automatic Compass Deviation Correction ..... 71
  - Further Heading Alignment Adjustment ..... 74
  - Checking Autopilot Operation ..... 74
  - Checking the Rudder Gain ..... 74
- Chapter 7: Maintenance ..... 77**
  - General ..... 77
  - Servicing and Safety ..... 77
  - Product Support ..... 77
- Chapter 8: Fault Finding ..... 79**
- Index ..... 81**



# Preface

This handbook contains information on the operation and installation of your ST7000 Plus. In order to obtain the best performance, please read this handbook thoroughly.

## How this Handbook is Organised

This handbook is divided into the following chapters:

**Chapter 1:** Introduces the ST7000 Plus Autopilot Control Unit, its features and use.

**Chapter 2:** Describes basic autopilot operation.

**Chapter 3:** Explains how to use Track and Wind modes and adjust autopilot performance. Also gives a summary of the ST7000 Plus alarms.

**Chapter 4:** Provides details on how to make adjustments to customise the ST7000 Plus and associated autopilot to give optimum performance on your vessel.

**Chapter 5:** Explains how to install the ST7000 Plus.

**Chapter 6:** Covers functional testing, initial calibration procedures after installation, and initial sea trials.

**Chapter 7:** Provides general maintenance procedures.

**Chapter 8:** Provides information to help you resolve any problems you may encounter with your autopilot.

An index is included at the end of this handbook, followed by a template for the installation of the control unit.

## Warranty

To verify the ownership of your new autopilot control unit, please take a few minutes to complete the warranty card. It is important that you complete the owner information and return the card to the factory to receive full warranty benefits.

## Safety Information

### WARNING

**Although the ST7000 Plus is designed to give accurate and reliable performance, it should serve only as an aid to navigation and should never lead to the erosion of good seamanship. Always maintain a permanent watch and be aware of situations as they develop.**

The following rules should always be observed:

- Maintain a permanent watch and regularly check all around for other vessels and obstacles to navigation – no matter how clear the sea may appear, a dangerous situation can develop rapidly.
- Maintain an accurate record of the vessel's position either by use of a radio navigation receiver or visual bearings.
- Maintain a continuous plot of position on a current chart. Ensure the locked autopilot heading steers you clear of all obstacles. Make proper allowance for Tidal Set – the autopilot cannot!
- Even when your autopilot is locked onto the desired Track using a radio navigation receiver, always maintain a log and make regular positional plots. Radio navigation signals can produce significant errors under some circumstances and the autopilot cannot detect this situation.
- Make sure that all members of crew are familiar with the procedures to disengage the autopilot.
- Ensure someone is present at the helm **AT ALL TIMES**, to take manual control in an emergency.
- As the fluxgate compass used in the autopilot system is a type of magnetic compass, it is susceptible to disturbances in the local magnetic fields, in the same way that a conventional ship's compass would be. It is therefore important that the fluxgate compass is installed and operated in a manner that will minimise the effects of any such local disturbances.

Your Raytheon autopilot will add a new dimension to your boating enjoyment. However, it is the responsibility of the skipper to ensure the safety of the vessel at all times by careful observance of these basic rules.

## **EMC Conformance**

All Raytheon equipment and accessories are designed to the best industry standards for use in the leisure marine environment.

Their design and manufacture conforms to the appropriate Electromagnetic Compatibility (EMC) standards, but good installation is required to ensure that performance is not compromised.





# Chapter 1: Introduction

## 1.1 Overview

The ST7000 Plus is a SeaTalk<sup>®</sup> compatible autopilot control unit. It can be used either as the control unit for a Type 100/300 Course Computer, or as a repeater, to allow control of autopilot types such as the ST4000 Plus, from a secondary location. It can also repeat instrument data by means of a programmable selection of Data Pages.

The autopilot system uses data transmitted from Autohelm SeaTalk instruments:

- Wind information from a wind instrument can be used for wind trim steering without the need to install a separate vane.
- Track information, from a navigation instrument, provides the ability to steer from waypoint to waypoint.
- Boat speed from the Speed instrument provides optimum track-keeping performance.

The ST7000 Plus can also be used with any navigator (GPS, Decca, Loran) transmitting NMEA 0183 data.

There are five operating modes:

**Standby:** Autopilot disengaged.

**Auto:** Autopilot engaged and locked onto a heading.

**Track:** Autopilot maintains a track between two waypoints created using a navigation system.

**Wind:** Autopilot maintains a course relative to an apparent wind angle.

**Manual:** Autopilot power steers rudder using joystick control.

When the ST7000 Plus is being used to repeat instrument data, “pop-up pilot” pages are displayed whenever a change in autopilot control is made. The duration of pop-up pilot pages is user-adjustable.

The ST7000 Plus also provides access to autopilot features such as:

- Automatic tack facility, which can be used in Auto and Wind modes.
- Automatic compass deviation correction.
- Northerly/Southerly heading compensation.
- Automatic heading deadband – seastate control.

- Waypoint advance feature.
- User Setup and Dealer Setup functions, to enable optimum performance to be achieved for a wide range of different types of vessel.

## **1.2 Specification**

- Power Supply: 10 to 15 V DC
- Current consumption:  
50 mA with display lamps off.  
120 mA with display lamps set at brightest level.
- Operating temperature: 0°C to +70°C (32°F to 158°F).
- Thirteen-button illuminated keypad.
- LCD display of heading, locked course, navigational, SeaTalk and NMEA data, with three levels of illumination.
- Two connections for SeaTalk.
- Input connection for NMEA.

# Chapter 2: Basic Operation

This chapter provides introductory operating information for your ST7000 Plus. Summary diagrams of the control key functions and screen layout are given, plus instructions for tasks such as engaging the autopilot, operating in Auto mode, changing the display lighting, and using Data Pages to display SeaTalk or NMEA data.

## 2.1 Key Functions

The autopilot is controlled using simple push-button operations, all of which are confirmed with a beep. In addition to the main single key functions, there are several dual key functions.

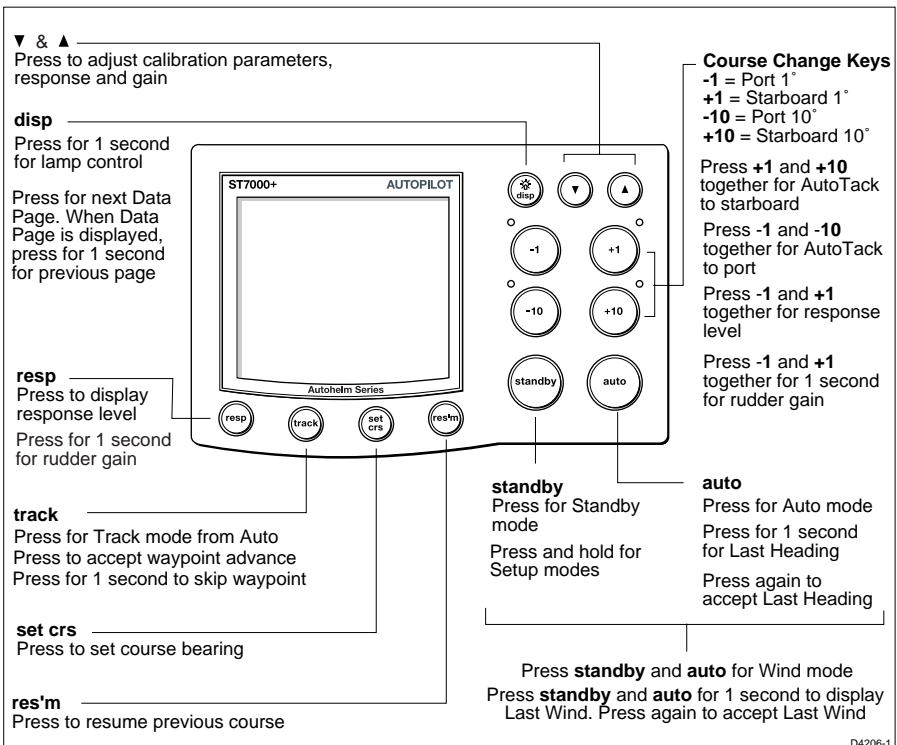

**Note:** The up arrow, down arrow, **resp**, **track**, **set crs** and **res'm** keys can also be used to set up and control groups of Autohelm ST60 and ST80 instruments (see Section 2.8, Remotely Controlling ST60 and ST80 Instruments and Section 4.3, Setting Up For ST60 and ST80 Remote Control).

## 2.2 Display Layout

The following illustration shows all the elements, together with a brief description, that make up the ST7000 Plus control unit LCD display.

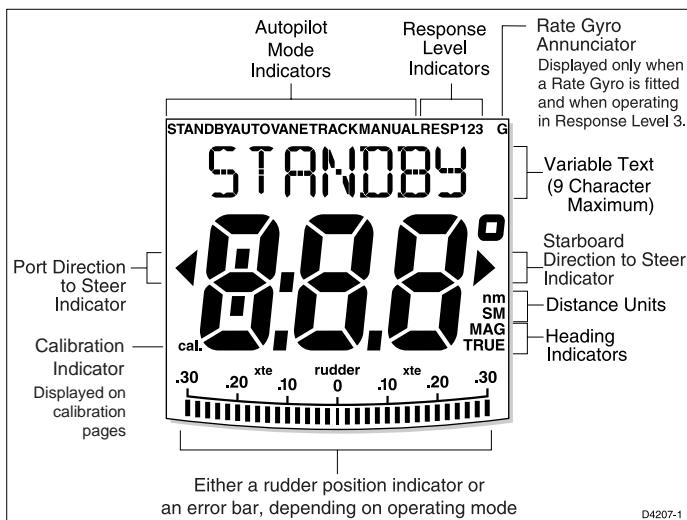

### Bar Graph

The bar graph at the bottom of the display can be set up either as a rudder position indicator, or as an error bar. If it has been set as an error bar, the display depends on the current autopilot mode, as follows:

Mode	Bar
Standby	Rudder position indicator, in degrees.
Auto	Heading error bar. Deviation from locked course, in degrees.
Track	Cross track error (XTE) bar. Deviation from ground track. The bar scaling is in the currently-selected distance units (displayed on pages showing distances).
Wind	Wind angle error bar. Deviation from locked apparent wind angle, in degrees.
Manual	Rudder position indicator

## Distance Units

Distance units are shown as either nm (nautical miles) or SM (statute miles). If neither nm nor SM is displayed, the displayed distance is in kilometres.

## 2.3 Start Up Conditions

When the ST7000 Plus is first switched on, it is in Standby mode with the display showing the vessel's current compass heading.

You can return to manual steering at any time by pressing **standby** momentarily, to return to Standby mode.

## 2.4 Using Auto Mode

### Safety

Although autopilot control can considerably ease the task of sailing a vessel, its use must never lead to the erosion of good-seamanship. ALWAYS maintain a permanent watch, no matter how clear the sea may appear to be.

Remember, a large ship can travel two miles in five minutes - just the time it takes to make a cup of coffee.

### Engaging the Autopilot (AUTO)

1. Steady the vessel on the required heading.
2. Press **auto**.

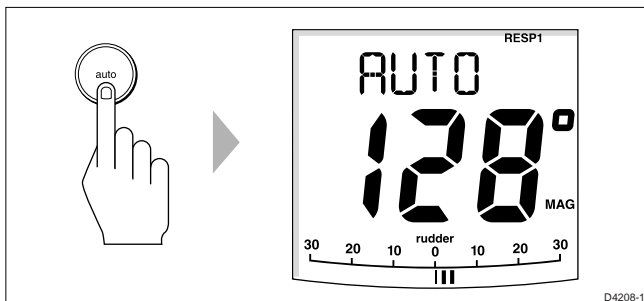

- In Auto mode, the display shows the locked autopilot heading.

## Return to Hand Steering

To disengage the Autopilot and return to Standby, press **standby**.

- The ST7000 Plus returns to Standby mode with the display showing the vessel's current compass heading.
- The previous autopilot heading is memorised and can be recalled (see *Returning to Previous Locked Heading* for details).

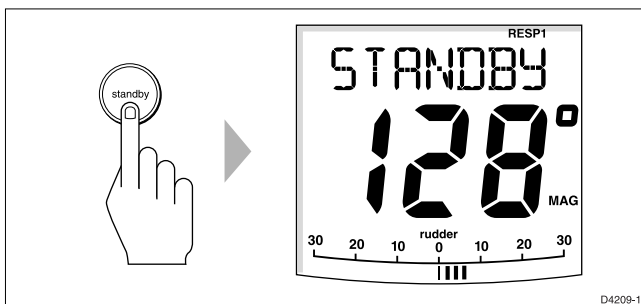

## Changing Course

There are two methods for changing to a new course. You can either:

- Set a new course directly (in Auto Mode)
- or
- Set up the course you want (in Auto or Standby Mode) and apply it at a specific time (e.g. to make a course change at a predetermined time or location), after confirming that you have set the correct course and the direction of turn is correct.

In both cases, the **+1** and **+10** (starboard) and **-1** and **-10** (port) keys are used to change the locked heading, in increments of 1° and 10°.

To set a new course directly, in Auto Mode, use the **+1** and **+10** (starboard) and **-1** and **-10** (port) keys as appropriate, to set the heading you want. The autopilot will turn on to the new course immediately it is set.

Example: a 30° course change to port = press **-10** three times.

To set a new course and apply it at a predetermined time or location:

1. Press **set crs**. The SET COURSE screen is then displayed.
2. Use the **+1** and **+10** (starboard) keys or the **-1** and **-10** (port) keys as appropriate to set the heading you want. The autopilot will not accept the new heading at this stage.

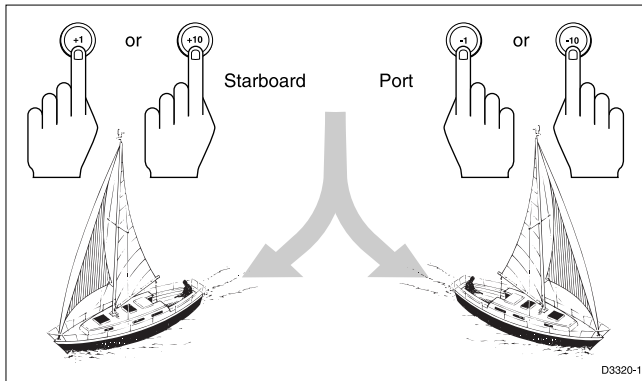

3. If you do not want to accept the new course at this time, either press the **disp** key or allow the display to timeout (10 seconds), to return to the pilot page.
4. To accept the new course at a later time, press **set crs** to re-display the new heading.
5. Press **auto**. A confirmation screen is then displayed. This shows the new heading and the direction the autopilot will steer (PORT or STARBOARD) to achieve the new heading.
6. Press **auto** again. The new heading is then applied and the autopilot assumes the new course.

## Dodging Obstacles in Auto Mode

In order to avoid an obstacle when your vessel is under autopilot control, select a course change in the appropriate direction (for example, port 30° = press **-10** three times).

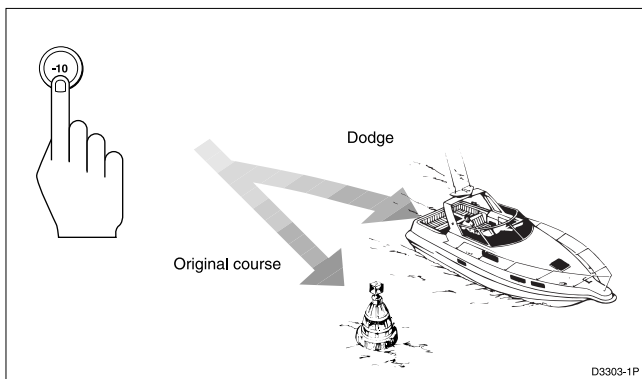



- When safely clear of the obstacle, you can resume the original course by using the course change keys (for example, press **+10** three times), or by using the previous locked heading.

## Returning to the Previous Locked Heading (LAST HEADING)

**Note:** *The previous locked heading is the most recent heading held for 20 seconds or more.*

If for any reason the vessel is steered away from the selected locked heading (for example, executing a dodge manoeuvre or selecting Standby) you can return to the previous locked heading:

1. Press **res'm**. The previous locked heading is displayed for 10 seconds and an appropriate direction-to-steer indicator flashes to show you the direction the vessel will turn if this heading is accepted.

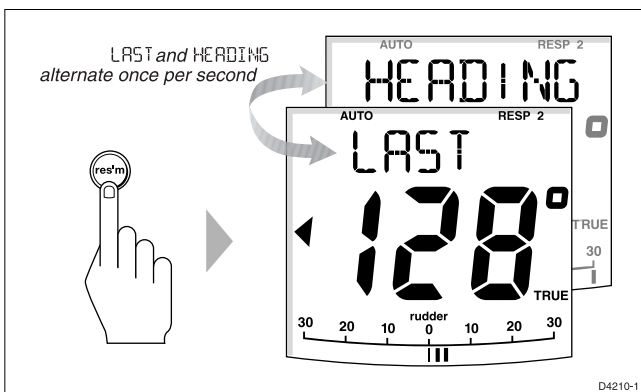

2. To accept the previous locked heading and resume the original course, press **auto** once within this 10 second period.

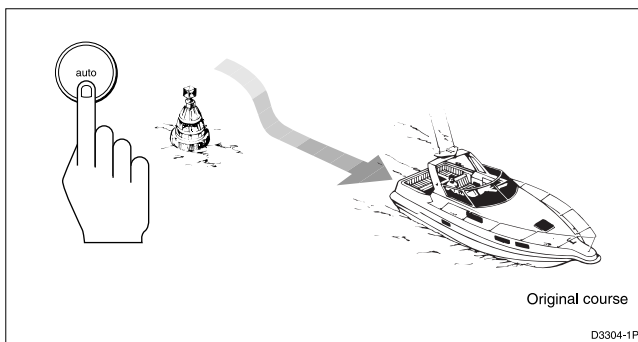

If you do not press **auto** while the display is flashing, the current heading will be maintained.

## Automatic Tack (AUTOTACK)

The ST7000 Plus can access an automatic tack facility that turns the vessel through a predetermined angle (the factory default is 100°) in the required direction.

### AutoTack to Starboard

- Press the **+1** and **+10** keys together to tack to starboard.

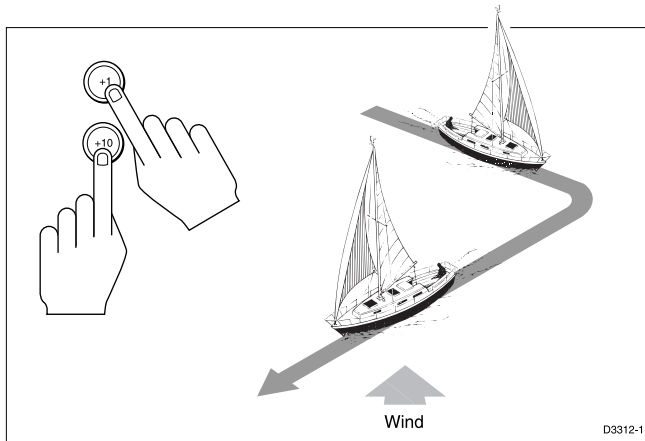

### AutoTack to Port

- Press the **-1** and **-10** keys together to tack to port.

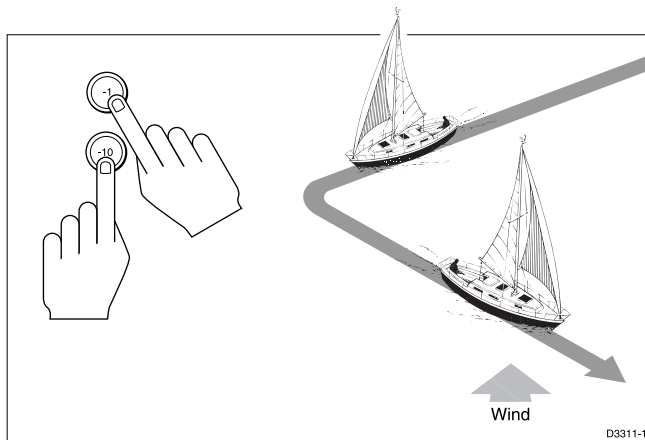

## Off Course Alarm

The off course alarm will sound if the locked autopilot heading and the vessel's current heading differ for more than 20 seconds, by more than the alarm angle set in calibration (the factory default is 20°).

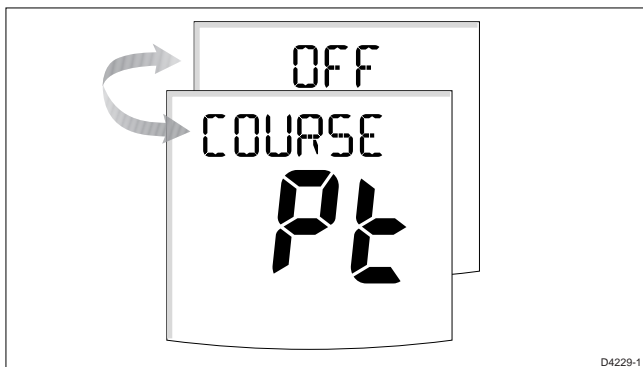

1. To cancel the off course alarm, press **standby** to return to hand steering.
2. Check whether your vessel is carrying too much sail, or whether the sails are badly balanced. Significant improvements in course keeping can usually be obtained by improving sail balance.

## Operating Hints

### Making Major Course Changes

- It is sound seamanship to make major course changes only when steering manually.
- Manual course changes ensure that obstructions or other vessels can be cleared properly, and due account taken of the changed wind and sea conditions on the new heading prior to engaging the autopilot.

### Course Changes Under Autopilot Control

It is important to understand the effect of sudden trim changes on steering performance. When a sudden trim change occurs, due, for example, to weather helm or sail imbalance, there will be a delay before the automatic trim applies rudder to restore the locked heading. This correction can take up to one minute.

Large course changes which change the apparent wind direction can produce large trim changes. In these situations, the autopilot will not

immediately assume the new automatic heading, and will only settle onto course when the automatic trim has been fully established.

To eliminate this problem, the following procedure can be adopted for large course changes:

1. Note the required new heading.
2. Select **standby** and steer manually.
3. Bring the vessel onto the new heading.
4. Select **auto** and let the vessel settle onto course.
5. Bring the vessel to the final course with 1° increments.

### Sailboats in Gusty Conditions

In gusty conditions, the course may tend to wander slightly, particularly if the sails are badly balanced. A significant improvement in course keeping can always be obtained by improving sail balance.

Bear in mind the following important points:

- Do not allow the yacht to heel over excessively.
- Ease the mainsheet traveller to leeward to reduce heeling and weather helm.
- If necessary, reef the mainsail a little early.

It is also advisable, whenever possible, to avoid sailing with the wind dead astern in very strong winds and large seas.

Ideally, the wind should be brought at least 30° away from a dead run and, in severe conditions, it may be advisable to remove the mainsail altogether and sail under headsail only.

Provided these simple precautions are taken, the autopilot will be able to maintain competent control in gale force conditions.

## 2.5 Using Manual Mode

If your system is fitted with a joystick, the ST7000 Plus will enter Manual mode when the joystick is used.

The ST7000 Plus will return to the previous operating mode when the joystick button is released, or to Standby mode if you press the **standby** key on the ST7000 Plus.

## 2.6 Setting Up Backlighting and Contrast

### Backlighting

To set the backlighting level:

1. Press **disp** for 1 second, from any mode, to enter illumination adjustment mode and turn the lights on.

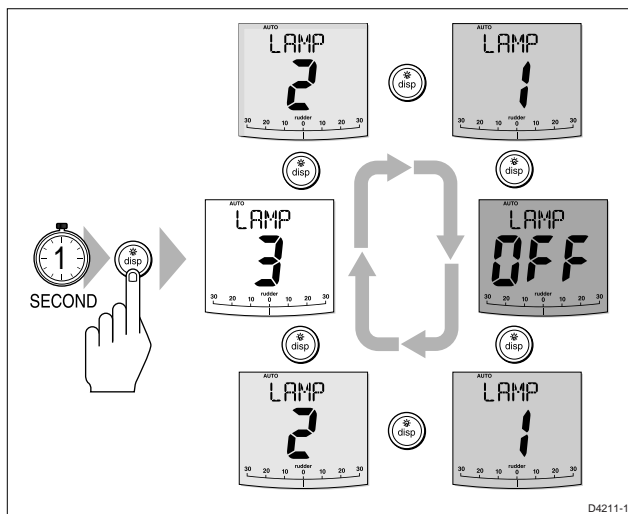

2. Press the **disp** key the necessary number of times to cycle to the required illumination setting. The settings are LAMP 3, LAMP 2, LAMP 1, LAMP OFF, LAMP 1, LAMP 2, LAMP 3 etc, with LAMP 3 being the brightest setting.

The display times out to normal operation after 10 seconds of keypad inactivity.

Pressing any other key before the 10 second time-out will select the mode assigned to that key (for example, **auto** selects Auto mode, **standby** selects Standby mode).

**Notes:** *If other SeaTalk instruments or autopilot control units are connected to SeaTalk, the illumination can be adjusted from these units.*

*Any illumination adjustments are lost when the unit is switched off. The keys are still lit at a courtesy level when the display lighting is off.*

## Contrast

To set the display contrast:

1. With the autopilot in Standby mode, hold down the **disp** key for 1 second to show the illumination adjust display.
2. Hold down the **disp** key for 1 second again, to display the CONTRAST adjust page.
3. Use the up and down arrow keys to set the required contrast level (from 1 to 15).

The display times out to normal operation after 10 seconds of keypad inactivity.

## 2.7 Data Pages

The **disp** key is used to cycle through Data Pages of SeaTalk or NMEA data. Once a Data Page is selected, this page becomes the principal autopilot display. The autopilot mode displays (Standby, Auto, Track Wind and Manual) then become “pop-ups”, and are displayed whenever the autopilot mode is changed or a course change is made. The duration of pop-up pages is user-adjustable, from 1 to 10 seconds. You can use Data Pages as follows:

- Press **disp** to display each Data Page in turn.
- When the last Data Page is cycled, the display returns to the current autopilot mode display (for example, Standby).
- To return to a previous Data Page, press **disp** for 1 second within 2 seconds of displaying a page. You can continue to move backwards through the Data Page sequence in this way.

Up to 15 Data Pages are available using the **disp** key. The number of pages, and the information displayed on each page, depends on the selections made in User Setup (see *Section 4.1*).

The following diagram shows the default Data Page settings.

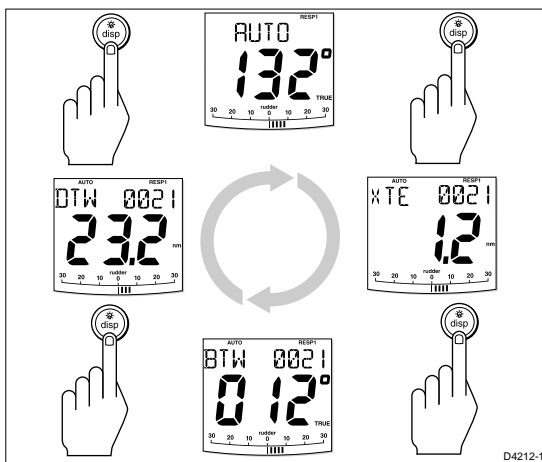

- If the required data for a page is not available, dashes are displayed instead of a value.
- Most displays are repeated data, and cannot be adjusted. The exceptions are the INST REM (ST60/ST80 Instrument Remote Control) and the MAXI REM (ST80 Maxiview Remote Control) pages (if selected for display). Setting up instructions for these are given in *Chapter 4, Customising the System*.
- The current autopilot mode is always shown at the top of the display, and the autopilot bar graph remains in use.

## Waypoint names

Where waypoint names have been allocated, they are displayed on the Distance To Waypoint (DTW), Cross Track Error (XTE) and Bearing To Waypoint (BTW) Data Pages.

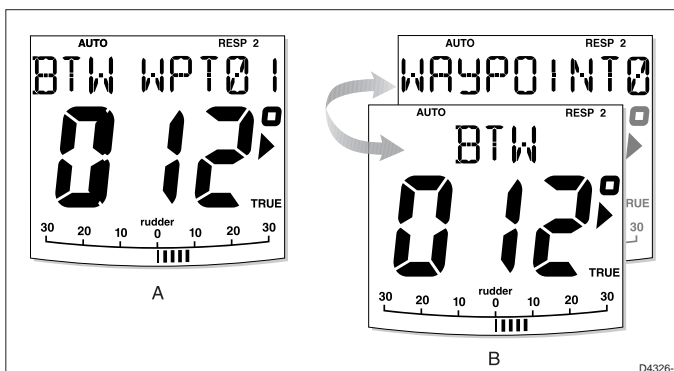

Waypoint names of five characters or less (as at A above) are displayed at the right of the screen. Waypoint names comprising more than five characters (as at B above) are centralised on the screen, alternating with the Data Page name.

When waypoint names have more than nine characters, only the first nine characters are displayed.

## 2.8 Remotely Controlling ST60 and ST80 Instruments

On vessels where the ST7000 Plus is used with ST60 or ST80 instrumentation, you can use the ST7000 Plus to control these instruments (both standard 110 mm, and Maxiview instruments). However, before attempting to operate ST60 or ST80 instruments in this manner, ensure the instrument grouping has been defined (see *Chapter 4, Customising the System*).

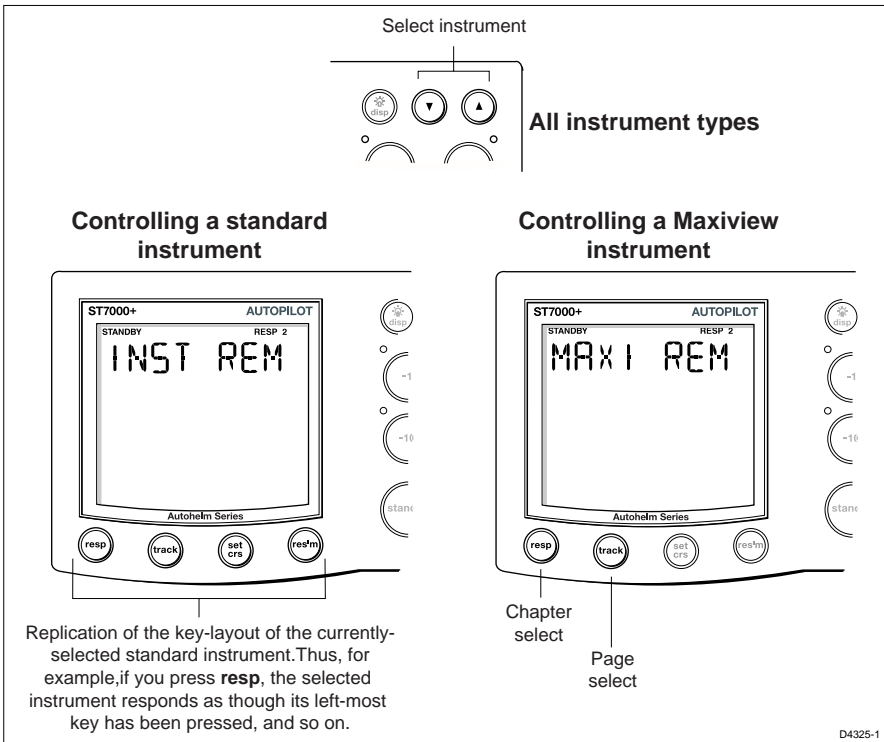



To operate ST60 or ST80 instruments from ST7000 Plus:

1. Select either the INST REM Data Page (for control of standard instruments) or the MAXI REM Data Page (for Maxiview instruments).
2. Using the summary of control functions shown in the following illustration, carry out the required instrument control functions from your ST7000 Plus.

**Note:** *The manner used to show a currently-selected instrument depends on the instrument type:*

- *On ST80 instruments, the characters are displayed in inverse video (i.e. white characters on a black background).*
- *On ST60 digital instruments, a REMOTE legend is displayed.*
- *On ST60 analogue instruments, either one or both of the TRUE/MAG or TRUE/APP annunciators flash on the digital display.*

# Chapter 3: Advanced Operation

This chapter provides information on:

- Operation in Track mode.
- Operation in Wind mode (WindTrim).
- Adjusting the response level and rudder gain.
- Alarms.

## 3.1 Operating in Track Mode

Track mode is used to maintain a track between two waypoints created on a GPS, Decca, or Loran navigation system. The autopilot will then compute any course changes to keep your boat on track, automatically compensating for tidal streams and leeway.

The ST7000 Plus can receive cross track error (the distance your vessel is from a planned track) from:

- A SeaTalk navigation instrument or chartplotter  
or
- A non-SeaTalk navigation system transmitting data in the NMEA 0183 format – this can be connected directly to the ST7000 Plus NMEA input, as described in *Chapter 5, Installation*.

Track mode is selected by pressing the **track** key, but can only be selected from Auto mode. You can return to either Auto or Standby mode from Track mode, as follows:

- Press **auto** to leave Track mode and return to Auto mode.
- Press **standby** to leave Track mode and return to manual steering.

**Note:** *The ST7000 Plus control head can be programmed to display various pages of navigation data, such as XTE, BTW etc. Please refer to Chapter 4 for details.*

### Initiating Track Mode

When initiating Track mode, the track can be acquired in one of two ways:

- Automatic acquisition, when cross track error and bearing to waypoint data are available.
- Manual acquisition, when cross track error is the only available data.

## Automatic Acquisition

Automatic acquisition can only be achieved if the pilot is receiving cross track error and bearing to waypoint information (via SeaTalk or NMEA 0183). It is initiated as follows:

1. Bring the vessel to within 0.1 nm of track.
2. Press **auto**.
3. Press **track** to enter Track mode, with the current locked heading displayed.

After a short delay for data acquisition, the Waypoint Advance alarm will sound, and the display will show the current bearing to waypoint alternating with the direction in which the boat will turn.

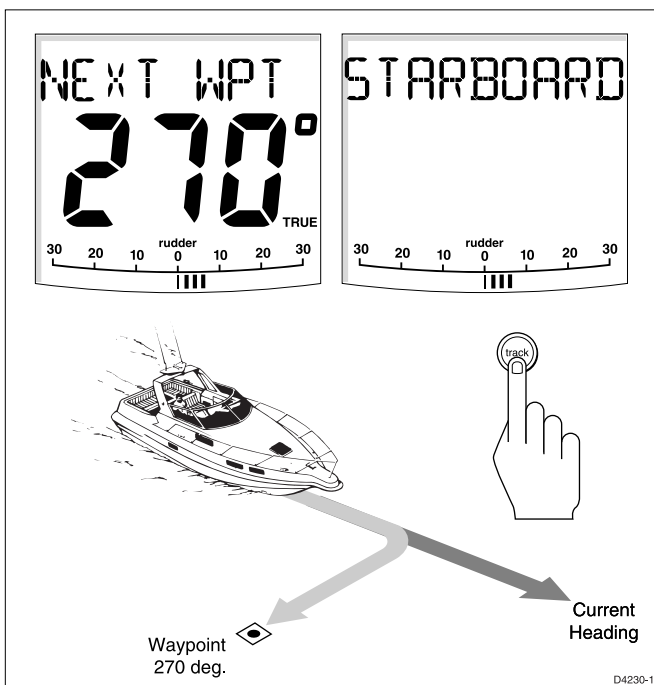

**Note:** If the vessel is further than 0.3 nm from the track, the Large Cross Track Error alarm will sound. Press **standby** to cancel the alarm, hand steer closer to the track, and press **auto** and **track** again.

4. Check that it is safe to turn onto the new course.
5. Press the **track** key. The boat will turn on to the new course and the alarm will be cancelled.

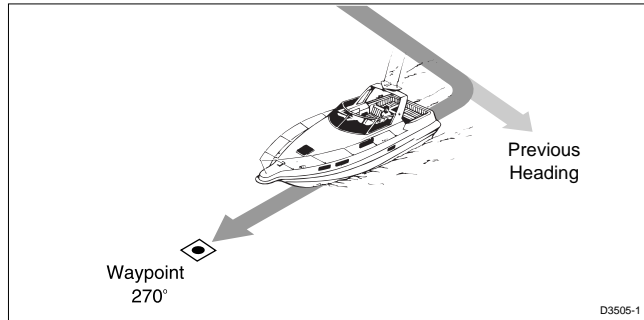
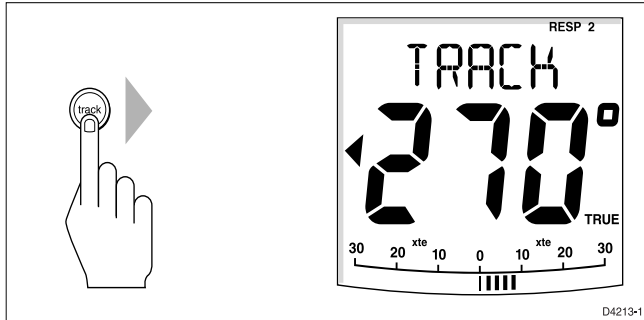

The display shows the new bearing to waypoint.

## Manual Acquisition

For manual track acquisition, when only cross track error data is available:

1. Steer the vessel to within 0.1 nm of track.
2. Bring the heading to within 5° of the bearing to the next waypoint.
3. Press **auto**.
4. Press **track** to enter Track mode.

The display shows the locked pilot heading.

**Note:** *At low speeds, the effect of tidal streams is far more significant than at higher speeds. Provided the tidal flow is less than 35% of the vessel's speed, no noticeable difference should occur in the performance of Track mode. However, extra care should be taken during manual acquisition, as follows:*

- *Ensure that the vessel is as close as possible to track, and the direction made good over the ground is as close as possible to the direction of the next waypoint, before selecting Track mode.*

- *Make positive positional checks at regular intervals, especially if navigational hazards are close by.*

## Cross Track Error

Cross track error (XTE) is the distance between the current position and a planned route. This is displayed in nautical miles (nm), statute miles (SM) or kilometres, and is taken directly from your navigator.

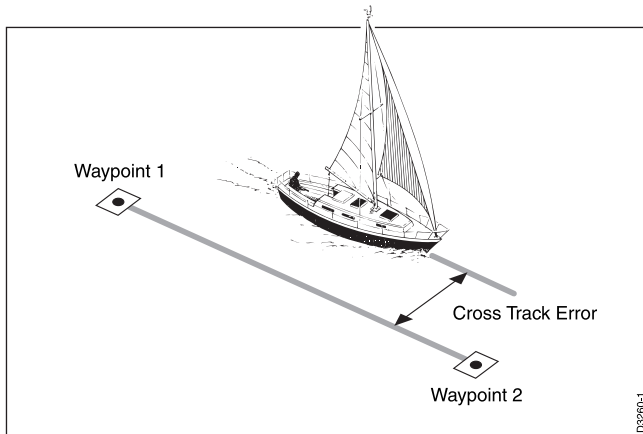

The Large XTE alarm sounds if the XTE exceeds 0.3 nm.

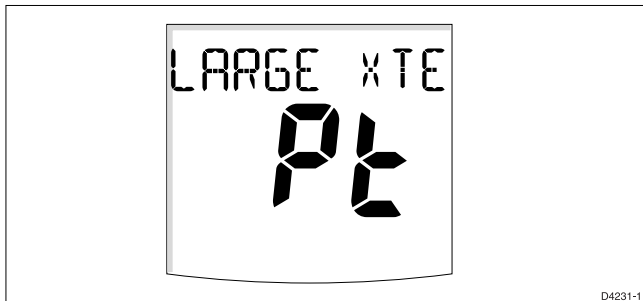

- The direction of the error is identified as Pt (port) or Stb (starboard).
- To cancel the alarm, either press **standby** to leave Track mode and return to Standby mode, or press **auto** to return to Auto mode.

**Note:** *If the Large Cross Track Error alarm sounds, it is usually an indication that the cross tide is too great for the vessel's current speed.*

## Tidal Stream Compensation

Under most conditions, Track mode will hold the selected track to within  $\pm 0.05$  nm (300 ft) or better. The autopilot takes account of vessel speed when computing course changes to ensure optimum performance over a wide range of vessel speeds. If speed data is available, the ST7000 Plus uses the measured vessel speed. Otherwise, the Speed Over Ground (SOG) or specified cruise speed is used, depending on the calibration setting (see *Dealer Setup* in *Chapter 4*).

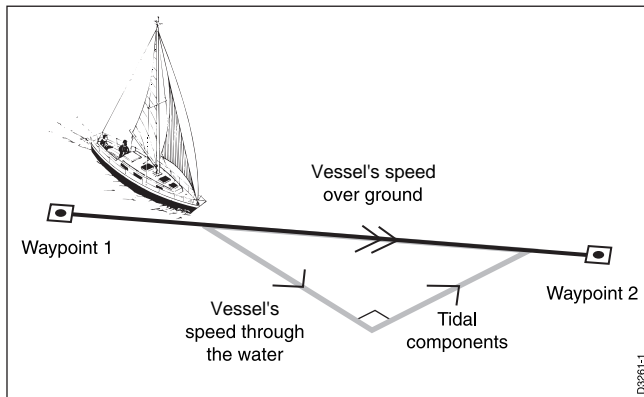

## Waypoint Arrival and Advance

If your navigation receiver transmits valid NMEA waypoint number and bearing to waypoint data, it is possible to advance from one waypoint to the next by pressing **track**. In order for the waypoint advance function to work, there must be at least one character difference in the names of adjacent waypoints.

### Arrival

As the vessel passes the target waypoint, the navigation receiver selects (manually or automatically) the next target waypoint.

The ST7000 Plus detects the new target waypoint number, sounds the Waypoint Advance alarm and displays Waypoint Advance information. This display shows the new bearing to waypoint and the direction the boat will turn to acquire the new track.

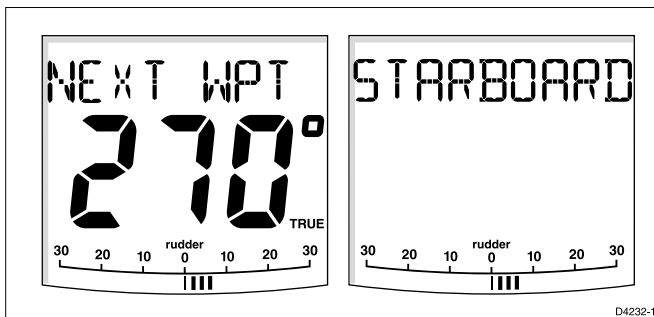

To accept the new target waypoint, press **track**.

### Skipping a Waypoint – SeaTalk Navigators Only

If you wish to advance to the next waypoint before you have arrived at the target waypoint, press **track** for 1 second. The Waypoint information for the next waypoint is displayed.

### Advance

While the waypoint advance alarm is sounding, Track mode is suspended and the autopilot maintains the current boat heading.

1. Check that it is safe to turn onto the new track.
2. Press the **track** key. This will cancel the waypoint arrival alarm and turn the boat towards the next waypoint.

***Note:** Unless the Waypoint Advance is accepted in the above manner, the alarm will continue to sound and the current heading will be maintained.*

## Dodges

Full control is still available from the keypad when the autopilot is in Track mode.

### Initiating a Dodge Manoeuvre

In track mode, dodge manoeuvres are accomplished by simply selecting the desired course change using the course change keys (**-1**, **+1**, **-10** or **+10**).

### Cancelling a Dodge Manoeuvre

Once the hazard has been avoided, the course change selected for the dodge manoeuvre should be cancelled by selecting an equal course

change in the opposite direction.

*Note: Provided the vessel remains within 0.1 nm of track, there is no need to steer back towards the track.*

## Safety

Passage making in Track mode removes the chores of compensating for wind and tidal drift, and will aid precise navigation. However, it is important to maintain an accurate log with regular plots.

### Position Confirmation at the Start of a Passage

At the start of a passage, always confirm the fix given by the position transducer, using an easily identifiable fixed object. Check for fixed positional errors and compensate for them.

### Verifying Computed Positions

Verify the computed position with a dead reckoned position, calculated from the average course steered and the distance logged.

### Plot Frequency

- In open water, plots should be at least hourly on sail boats and more frequently on power boats.
- In confined waters, or when potential hazards are near, plots should be more frequent.
- Local variations in radio signal quality, and changes in the tidal stream, will produce deviations from the desired track.

### Setting Waypoints

- When setting waypoints, remember that deviations will occur.
- Thoroughly check along each track.
- Check up to 0.5 nm each side of the track to ensure that there are no hazards within the zone.

### General

The use of track mode will enable accurate track keeping even in complex navigational situations. However, it cannot remove the responsibility of the skipper to ensure the safety of his vessel at all times by careful navigation and frequent position checks.



## 3.2 Operating in Wind Mode (WindTrim)

Wind mode (also known as WindTrim) allows the ST7000 Plus to maintain a course relative to an apparent wind angle. It uses wind trim to eliminate the effects of turbulence and short term wind variations, and provides smooth precise performance under Wind mode operation with minimal power consumption.

Wind mode uses the fluxgate compass as the primary heading reference and, as changes in the apparent wind angle occur, the locked compass heading is adjusted to maintain the original apparent wind angle.

To use Wind mode, the ST7000 Plus must receive wind information from one of the following sources:

- SeaTalk Wind instrument, connected to a ST7000 Plus via SeaTalk.
- NMEA wind information.
- Autohelm wind vane connected to a SeaTalk interface box.

### Selecting Wind Mode

Wind mode can be selected from either Standby or Auto modes, as follows:

1. Steady the vessel onto the required apparent wind angle.
2. Press **standby** and **auto** together to select Wind mode and lock the current apparent wind angle.

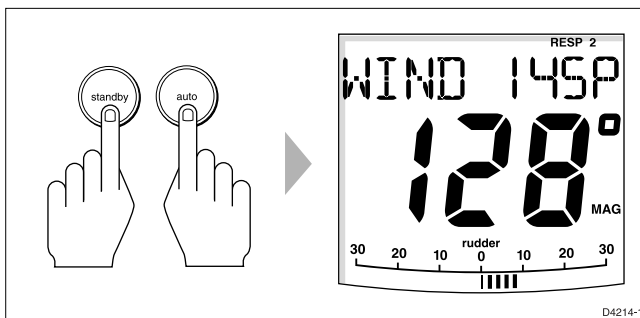

- The locked heading is displayed along with the apparent wind angle.
- The boat heading is adjusted by the pilot to maintain the locked apparent wind angle.

## Adjusting the Locked Wind Angle

The locked wind angle can be adjusted by changing course using the **-1**, **+1**, **-10** and **+10** keys.

For example, to bear away by  $10^\circ$  when the vessel is on starboard tack, press -10 to turn the vessel  $10^\circ$  to port. The locked apparent wind angle and locked heading both change by  $10^\circ$ . The new apparent wind angle is maintained, and the locked heading adjusted by the autopilot as required.

**Note:** *This method should only be used for minor adjustments to the apparent wind angle, since turning the boat affects the relationship between the true and apparent wind angles. For major changes, return to Standby mode, steer onto the new heading, and reselect Wind mode.*

## Returning to the Previous Apparent Wind Angle (LAST WIND)

If for any reason the vessel is steered away from the selected apparent wind angle (for example, a dodge manoeuvre or selecting Standby) you can return to the previous locked wind angle:

1. Press **res'm** to display the previous apparent wind angle (LAST WIND).

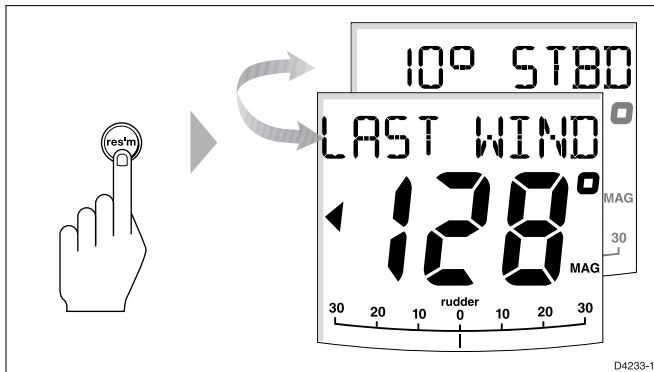

The LAST WIND text alternates with the previous wind angle and direction (PORT or STBD). The previous locked heading is displayed, with an indicator to show you the direction in which the vessel will turn.

2. Check that it is safe to turn on to this course.
3. To accept this apparent wind angle, press **standby** and **auto** together within 10 seconds.

If you do not accept the previous wind within this time, the autopilot locks on to the current apparent wind angle.

## Dodges

Full control is still available from the keypad when the autopilot is in Wind mode.

- Dodge manoeuvres are accomplished by simply selecting the desired course change using the course change keys (**-1**, **+1**, **-10** and **+10**). Both the locked heading and locked apparent wind angle are adjusted.
- Once the hazard has been avoided, you can reverse the previous course change, or return to the previous apparent wind angle (LAST WIND).

## Wind Shift Alarm

The wind shift alarm sounds, and the text WINDSHIFT is displayed, if a wind shift of more than 15° is detected.

1. Press **standby** to cancel the alarm and return to hand steering, and steer onto the required heading.
2. Press **standby** and **auto** together to return to Wind mode with the new apparent wind angle.

## Using AutoTack in Wind Mode

The automatic tack function tacks the vessel through a set angle (the factory default is 100°). The locked heading can then be adjusted until the required apparent wind angle is achieved.

- To tack to starboard, press **+1** and **+10** together momentarily.
- To tack to port, press **-1** and **-10** together momentarily.

**Note:** *In order to obtain optimum performance when using AutoTack in Wind mode, it is important that the wind vane is accurately centred when it is installed.*

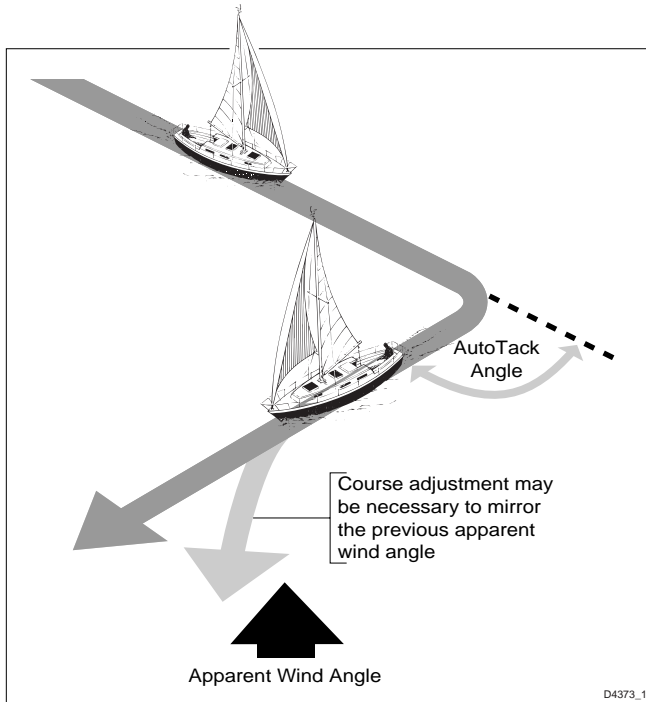

## Operating Hints

- Major changes to the selected apparent wind angle should be made by returning to Standby mode, changing course manually, then reselecting Wind Mode.
- Wind mode filters the windvane output. This provides the optimum response for off-shore conditions where genuine shifts in wind direction occur gradually.
- In gusty and unsteady inshore conditions, it is best to sail a few degrees further off the wind so that changes in apparent wind direction can be tolerated.
- It is important to ensure that the amount of standing helm is minimised by careful sail trimming and positioning of the mainsheet traveller.
- The headsail and mainsail should be reefed a little early rather than too late.

### 3.3 Adjusting Autopilot Performance

The response level and rudder gain can be adjusted during normal operation using the **resp** key.

The calibration settings for response and rudder gain (see *Dealer Setup* in *Chapter 4*) are restored when the system is powered on.

#### Changing the Response Level

The response level controls the relationship between the autopilot's course keeping accuracy and the amount of helm/drive activity.

- **Response Level 1**, AutoSeastate (Automatic Deadband), causes the autopilot to gradually ignore repetitive movements of the vessel and only react to true variations in course. This provides the best compromise between power consumption and course keeping accuracy, and is the default calibration setting.
- **Response Level 2** (Minimum Deadband) provides the tightest course keeping possible by applying an amount of rudder proportional to the heading error. However, tighter course keeping results in increased power consumption and drive unit activity.
- **Response Level 3** (also Minimum Deadband) provides the tightest course keeping possible by introducing yaw damping.

The response can be changed at any time. To do so:

1. Press either the **resp** key or press the **+1** and **-1** keys together momentarily to display the Response screen.

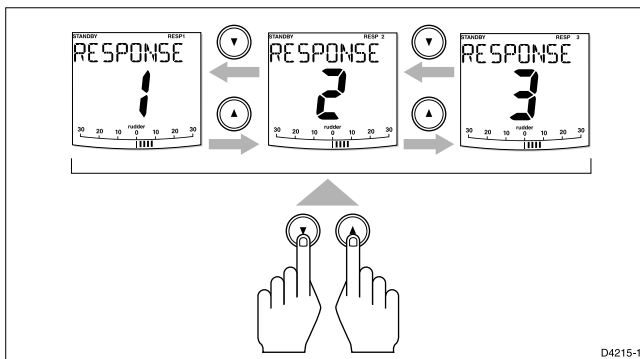

2. Use the up-arrow and/or down-arrow keys to change the response level.

3. Wait for 10 seconds, or press **disp**, to return to the previous display.

## Changing the Rudder Gain

Press either the **resp** key for 1 second or the **+1** and **-1** keys together for 1 second to display the Rudder Gain screen, and adjust the setting in the same way as for the response level. Refer to *Chapter 6, Post Installation Procedures*, for instructions on how to check that the rudder gain is set correctly.

### WARNING

**It is important that the rudder gain is correctly set on planing craft. Incorrect adjustment will lead to poor steering performance and is dangerous at high speeds.**

## 3.4 Alarms

This section summarises the alarms that are reported by the ST7000 Plus.

Unless otherwise stated, alarms can be cleared by pressing **standby**, to return to the Standby mode, i.e. hand steering.

### SeaTalk Failure

SEATALK alternating with FAILURE

This silent alarm indicates that the SeaTalk bus is not operating correctly. Can only be cleared by rectifying the fault.

### No Link

NO LINK

This silent alarm indicates either a faulty autopilot or a disconnection between the ST7000 Plus and the course computer. Can only be cleared by rectifying the fault.

## Off Course

OFF alternating with COURSE

This alarm is activated when the vessel has been off course from the locked heading by more than the specified angle for more than 20 seconds (see *Using Auto Mode* in *Chapter 2*).

The alarm is cleared if the heading recovers or the course is changed, or if the operating mode is changed.

## Wind Shift

WIND alternating with SHIFT

This alarm is activated when a change in the apparent wind angle requires an adjustment of the locked heading by more than 15° (see *Operating in Wind Mode* in this Chapter).

## Large Cross Track Error

LARGE XTE

This alarm is activated when the cross track error exceeds 0.3 nm (see *Operating in Track Mode* in this Chapter).

The alarm is cleared if the cross track error falls below 0.3 nm, or if the operating mode is changed.

## Drive Stopped

DRIVE alternating with STOPPED

This alarm is activated if the autopilot is unable to turn the rudder. This occurs if the weather load on helm is too high, or if the requested rudder position is past the preset rudder limits or the rudder end-stops.

## Data Not Received

NO DATA

This alarm is displayed in the following circumstances:

- Track mode is engaged and the autopilot is not receiving SeaTalk navigation data.

- Track mode is engaged and the position transducer (GPS, Loran, Decca) is receiving a low strength signal – this will clear as soon as the signal strength improves.
- Wind mode is engaged and the autopilot has not received wind angle data for 30 seconds.

The autopilot stops adjusting the locked heading as soon as data is lost.

## Waypoint Advance

### NEXT WPT

The waypoint advance alarm sounds whenever the target waypoint number changes, which occurs in the following circumstances:

- Automatic acquisition is selected by pressing **track** from Auto mode
- Waypoint arrival. Vessel arrives at the target waypoint and moves onto the next waypoint in the route.
- Waypoint advance is requested by pressing **track** for 1 second in Track mode (SeaTalk Navigators only).

When the alarm sounds, the pilot continues on its current heading, but displays the bearing to the next waypoint and the direction in which the boat will turn to take up that bearing.

Check that it is safe to turn onto the new track, and press **track** to accept the waypoint advance.

To cancel the alarm without accepting the waypoint advance, press **standby** to return to hand steering, or **auto** to return to Auto.

**Note:** *The waypoint advance will only operate on pilots receiving valid bearing to waypoint and waypoint number information.*

## Low Battery

### LOW alternating with BATTERY

The Low Battery alarm sounds when the supply voltage drops below acceptable limits.

Press **standby** to clear the alarm and return to hand steering.

Start the engine to recharge the battery.



## Watch Alarm

### WATCH

The Watch alarm is activated in Watch mode when the timer reaches 4 minutes. It is not available from Standby mode.

If you wish to set the Watch mode, the WATCH screen must be configured as one of the Data Pages (see *User Setup in Chapter 4*).

To set and control the Watch alarm:

1. Select Auto, Track or Wind mode.
2. Press the **disp** key until the WATCH Data Page is displayed.
  - The Watch timer starts counting.
  - When the timer reaches 3 minutes, the text on the display starts flashing to indicate the last minute of Watch alarm.
  - When the timer reaches 4 minutes, the audible Watch alarm activates.
3. Press **auto** at any time to silence the alarm and reset the timer to 4 minutes. (Pressing any other key resets the timer and performs the key's normal function).
4. To clear Watch mode, press **disp** to display a different page, or press **standby**.

**Note:** *You cannot engage Auto mode from the Watch mode – pressing **auto** merely resets the Watch timer.*

## Route Completed

### ROUTE alternating with COMPLETED

Occurs when you have reached the last waypoint.

To cancel the alarm, select either Standby, Auto or Wind mode.

## AutoRelease

### AUTO alternating with RELEASE

Occurs on stern drive vessels if you manually take over steering and the autopilot relinquishes control.

The alarm cancels automatically after 10 seconds.

## Shallow

### SHALLOW

Occurs when the water depth is less than the SHALLOW value defined by the associated SeaTalk Depth instrument.

To cancel the alarm, either press any key on the ST7000 Plus or cancel it at the Depth instrument.

## Man Overboard (MOB)

If a man overboard (MOB) message is received from another instrument on the SeaTalk system, the text MOB is shown instead of the waypoint number for the XTE, DTW and BTW Data Pages.

If the autopilot is operating in Track mode, the Waypoint Advance alarm will sound to notify the change in waypoint.



# Chapter 4: Customising the System

The ST7000 Plus provides setup and configuration options that are used to adjust the settings for the ST7000 Plus itself, the compass, and the autopilot.

**Note:** *You should perform the post installation procedures described in Chapter 6 before adjusting any other calibration features.*

There are two setup levels:

- **User Setup**, which controls pilot type set up, tack angle set up, compass set up, rudder calibration and the ST7000 Plus display features.
- **Dealer Setup**, which controls the autopilot settings, and also the calibration lock which can be used to prevent accidental access to User Setup.

**Note:** *If the vessel type is changed, you must then relinearise the fluxgate compass.*

## Important

**If your ST7000 Plus is part of a system which includes one or more ST80 Masterview instruments, you must turn OFF the pop-up pilot facility on each ST80 Masterview before attempting to carry out either *User Setup* or *Dealer Setup* at the ST7000 Plus.**

Once the *User Setup* and/or *Dealer Setup* procedures have been completed, return each ST80 Masterview to the condition it was in prior to setting up the ST7000 Plus.

## 4.1 User Setup

The flow chart on the following page shows the User Setup control procedure, and the setup screens with their default settings. Information on the functions of the different settings is given in the remainder of this section.

The following points should be considered:

- Make sure that the autopilot is in Standby mode before you access User Setup.
- If the CAL LOCK screen is displayed instead of the initial page, you need to turn off the lock feature in Dealer Setup.
- Setup options are always saved on exit.

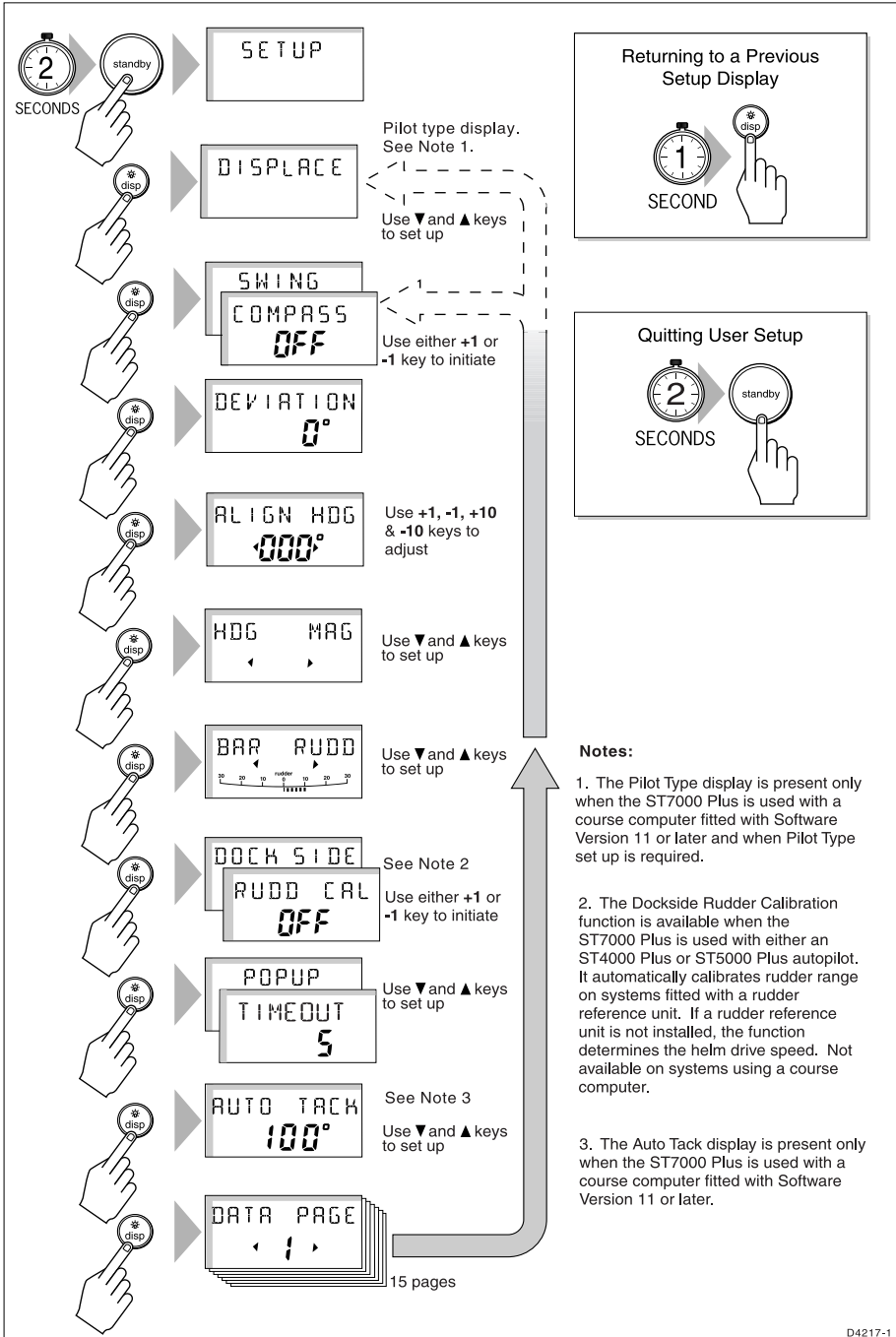

## Pilot Type

The pilot type screen enables you to define your autopilot configuration as follows:

- DISPLACE (displacement)
- SEMI alternating with DISPLACE (semi-displacement)
- PLANING
- STERN DRV

The pilot type screen is displayed only when the User Setup routine is entered for the first time and only when the ST7000 Plus is being used in conjunction with a Type 100/300 Course Computer using Software Version 11 or later.

## Compass Deviation Correction (SWING COMPASS)

The compass deviation correction option allows you to correct the compass for deviating magnetic fields. The procedure must be performed as the first item in your initial sea trial, and is described in detail in *Chapter 6, Post Installation Procedures*.

## Deviation Display (DEVIATION)

The deviation screen shows the current deviation value, calculated from the correction procedure (SWING COMPASS). You cannot edit this value.

## Heading Alignment (ALIGN HDG)

The heading alignment screen shows the current reported heading.

**Note:** *You should always check the compass alignment after performing a compass deviation correction (see Chapter 6, Post Installation Procedures). However, once the initial correction procedure has been performed, you can make adjustments to the alignment as often as you wish, without re-correcting your compass.*

- Steer your vessel onto a known heading, and check the heading displayed.
- If required, adjust the heading value to match the known value, using the **+1**, **-1**, **+10** and **-10** keys.

## Heading Mode (HDG)

Select either magnetic or true heading mode. When heading data is displayed in normal operation, the screen indicates whether true or magnetic mode has been selected.

## Bar Selection (BAR)

Select the type of bar graph that is shown at the bottom of the SeaTalk displays. The options are:

**BAR OFF:** The bar graph is not displayed.

**BAR RUDD:** This shows the rudder position, and is the default setting. Note that a rudder reference transducer is required for accurate rudder position information.

**BAR ERROR:** The bar graph is used as follows:

Mode	Bar
Standby	Rudder position
Auto	Heading error bar
Track	Cross track error (XTE) bar
Wind	Wind angle error bar
Manual	Rudder position

## Rudder Calibration (DOCK SIDE/RUDD CAL)

### WARNING

**This procedure moves the helm, and should only be used when the vessel is at the dockside. For sterndrive systems, the engines must be running before you start the procedure.**

The Dockside Rudder Calibration function is available when the ST7000 Plus is used with either an ST4000 Plus or ST5000 Plus autopilot. It performs an automatic calibration of the rudder range, for systems with a rudder reference unit. If a rudder reference unit is not installed, the function determines the helm drive speed.

The auto dockside procedure is not available if the ST7000 Plus is used with a Type 100/300 Course Computer. If you try to use this function with a Course Computer, the display shows AUTO N/A.

If you start the procedure by mistake, press any key to cancel it.

## Popup Timeout (POPOP/TIMEOUT)

Sets the period for which autopilot mode pages (Standby, Auto, Track, Wind and Manual) pop up when Data Pages are displayed. Adjustable from 1 to 10 seconds.

## Auto Tack (AUTO TACK)

The Auto Tack function can only be used when the ST7000 Plus is used with a Type 100/300 Course Computer, fitted with software Version 11 or later.

Use the Up and Down arrow keys to set the default auto tack angle.

## Data Pages (DATA PAGE)

The next 15 pages of User Setup allow you to change the default settings for the Data Pages. These are the pages of SeaTalk or NMEA data available for display using the **disp** key during normal operation (see *Data Pages* in *Chapter 2*).

Each of the setup pages initially shows the title DATA PAGE. After 1 second, this changes to show the title of the data currently set for that page. The available pages are as follow:

<b>Data</b>	<b>Displayed as</b>
Vessel Speed	SPEED (followed by units)
Log	LOG (followed by units)
Trip	TRIP (followed by units)
Average Vessel Speed	AV SPD (followed by units)
Wind Direction	E.g. WIND PORT
Wind Speed	WIND (followed by units)
Depth Metres	DEPTH M
Depth Feet	DEPTH FT
Depth Fathoms	DEPTH FA
Heading	HEADING

continued ...



<b>Data</b>	<b>Displayed as</b>
Water Temperature, Degrees C	WATER °C
Water Temperature, Degrees F	WATER °F
Course Over Ground	COG
Speed Over Ground	SOG (followed by units)
Cross Track Error	XTE (followed by units)
Distance to Waypoint	DTW (followed by units)
Bearing to Waypoint	BTW
Watch	WATCH
Universal Time Constant	UTC
ST60/ST80 Instrument Remote Control	INST REM
Maxiview Remote Control	MAXI REM

The units displayed for all data other than depth and water temperature depend on the currently selected SeaTalk display units.

The default pages are:

<b>Data Page</b>	<b>Default Setting</b>
1	XTE (Cross Track Error)
2	BTW (Bearing to Waypoint)
3	DTW (Distance to Waypoint)
4 to 15	NOT USED

For each setup page, scroll forwards or backwards using the **+1** or **-1** keys, until the required page title is displayed.

Press **disp** to move on to the next Data Page selection screen, and repeat the selection procedure.

#### **Notes:**

1. If you set a page to **NOT USED**, it is omitted from the display cycle during normal operation. For example, with the default page settings only three pages are displayed in the sequence.

2. *There are three depth pages and two water temperature pages. Data is displayed in the units defined by the selected page.*
3. *If a man overboard (MOB) message is received by the autopilot, the BTW and DTW pages will display the bearing and distance to the MOB location, so it is good practice to retain these pages for display.*

## Software Version Number

To check the Version of software in ST7000 Plus, hold down the **standby** key for 4 seconds.

The ST7000 Plus software version screen and the course computer software number screen are then displayed alternately.

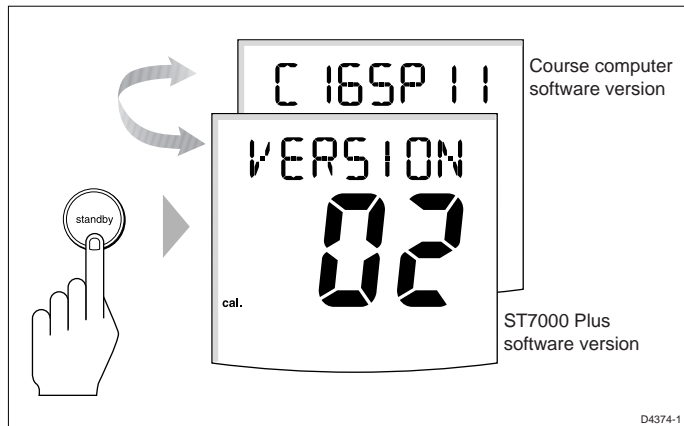

## 4.2 Dealer Setup: Type 100/300 Course Computer

This section applies if you have installed the ST7000 Plus as the control unit for a Type 100/300 Course Computer. If you are using the ST7000 Plus as a repeater for another autopilot system, refer to the Dealer Setup instructions in the handbook for the main control unit.

Dealer Setup is used to customise the autopilot to your boat. However, once the Pilot Type is set, the factory defaults will provide safe performance for initial sea trials, and fine tuning is not normally required. The flow chart below shows you how to enter Dealer Setup, scroll through the setup displays, adjust the values and exit.

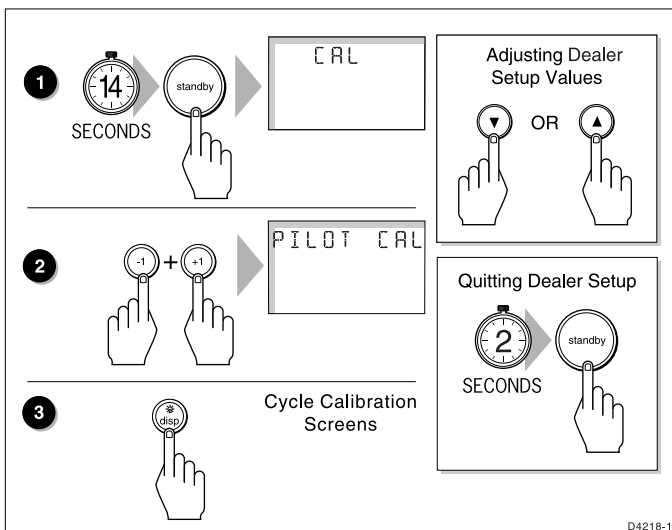

## Recommended Settings

This section details the calibration settings for sailing/power displacement and planing power vessels. Once you have set the Pilot Type, these will provide good performance for initial sea trials and can be fine tuned later to optimise performance.

After initial calibration has been carried out, further adjustment can be made at any time.

The adjustable features are listed in a table at the end of this section, Use this table to record your settings for future reference. Information on the functions of the different settings is given in the remainder of this section.

The following points should be noted:

- Make sure that the autopilot is in Standby mode before you access Dealer Setup.
- Setup options are always automatically saved on exit.

## Pilot Type

This should be set when the system is first switched on. The default settings for other Dealer Setup options depend on the pilot type you select here.

Setting	Description
DISPLACE	Displacement
SEMI/ DISPLACE	Semi-displacement
PLANING	Planing
STERN DRV	Sterndrive
<b>Default:</b>	DISPLACE

### Calibration Lock

Calibration lock controls the access to User Setup, and is intended for charter boat users.

Setting	Description
ON	User setup locked
OFF	User setup unlocked
<b>Default:</b>	OFF

### Rudder Gain

This must be set while under way, as described in *Chapter 6, Post Installation Procedures*.

Range:	1 to 9	
<b>Default:</b>	for Pilot Type Displacement	5
	for Pilot Type Semi-Displacement	5
	for Pilot Type Planing	4
	for Pilot Type Stern drive	3

### Rate Level

Rate Level applies rudder to reduce the rate of change of course. If the vessel is turning at too fast a rate, the rate level will counter this turn with opposite rudder.

The settings available are as follows:

---

Range: 1 to 9

---

**Default:**

for Pilot Type Displacement	7
for Pilot Type Semi-Displacement	7
for Pilot Type Planing	7
for Pilot Type Stern drive	5

---

## Rudder Offset

You only need to set this option if your system includes a rudder reference unit.

- Manually place the helm in a central position. The reported rudder angle is indicated on the rudder bar graphic at the bottom of the screen.
- Adjust the offset value, using the **+1** and **-1** keys, until the rudder position is shown as central on the rudder bar. The offset must be within the range  $-7^{\circ}$  to  $+7^{\circ}$ .

---

Range:  $-7^{\circ}$  to  $+7^{\circ}$

---

**Default:**  $0^{\circ}$

---

## Rudder Limit

Rudder Limit restricts autopilot rudder movement to just less than the steering systems mechanical stops. This avoids putting the steering system under unnecessary load.

---

Range:  $15^{\circ}$  to  $40^{\circ}$

---

**Default:**

for Pilot Type Displacement	$30^{\circ}$
for Pilot Type Semi-Displacement	$30^{\circ}$
for Pilot Type Planing	$30^{\circ}$
for Pilot Type Stern drive	$20^{\circ}$

---

## Turn Limit

This limits the rate of turn of your vessel when making a course change under autopilot control. The value must be within the range 5 to  $20^{\circ}$ . For sailboat applications it should be set to  $20^{\circ}$ .

---

<b>Range:</b>	5° to 20°/second	
<b>Default:</b>	for Pilot Type Displacement	20°/second
	for Pilot Type Semi-Displacement	15°/second
	for Pilot Type Planing	15°/second
	for Pilot Type Stern drive	08°/second

---

## Cruise Speed

Cruise speed should be set to the boat's normal cruising speed if boat speed is not available via SeaTalk or NMEA – SeaTalk boat speed is used in preference to SOG.

---

<b>Range:</b>	4 to 60 knots	
<b>Default:</b>	for Pilot Type Displacement	6
	for Pilot Type Semi-Displacement	8
	for Pilot Type Planing	15
	for Pilot Type Sterndrive	15

---

## Off Course Alarm

This feature controls the alarm that warns you if the pilot is unable to maintain its set course. The alarm operates if the autopilot strays off course by more than the alarm angle limit for more than 20 seconds.

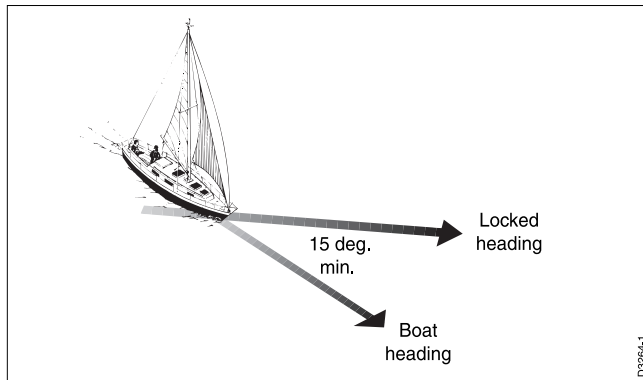

The value must be within the range 15 to 40°, and can be adjusted in 1° steps.

---

<b>Range:</b>	15 to 40°
<b>Default:</b>	20°

---

## AutoTrim

The AutoTrim level setting determines the rate at which the autopilot applies “standing helm” to correct for trim changes caused by varying wind loads on the sails or superstructure.

The settings are:

Setting	Effect	Recommended for:
OFF	No trim correction	
1	Slow trim correction	Heavy displacement vessels, with full keel or transom rudder.
2	Medium trim correction	Heavy displacement vessels.
3	Fast trim correction	Some planing and moderate to light displacement vessels.
4	Super fast correction	Fast planing power vessels
<b>Default:</b>	for Pilot Type Displacement	2
	for Pilot Type Semi-Displacement	3
	for Pilot Type Planing	3
	for Pilot Type Sterndrive	3

The default setting should provide optimum performance with the Course Computer. However, an incorrect rate of trim application may result in poor course-keeping due to autopilot instability, depending on the dynamic stability of the vessel.

After gaining experience with the Course Computer, you may wish to change the setting. The effect of the setting must be evaluated while under sail.

- Decrease the AutoTrim level if the autopilot gives unstable course-keeping or excessive drive activity with a change in the heel angle.
- Increase the AutoTrim level if the autopilot reacts slowly to a heading change due to a change in the heel angle.
- For systems without a rudder reference unit, these settings have no effect and trim is set to level 3.

## Power Steer

Power steer selects the Joystick mode of operation: Proportional or ‘Bang-Bang’.

Proportional applies rudder in proportion to Joystick movement - the further the Joystick is held over the greater the applied rudder.

Bang-Bang applies continuous rudder drive in the direction of lever movement. To improve control the speed of rudder movement changes with the angle of the lever. For maximum speed push the lever hard over. If the lever is returned to the centre position the rudder will remain in its current position.

---

Range:	OFF 1 = Proportional 2 = Bang-bang
--------	--

---

<b>Default:</b>	OFF
-----------------	-----

---

## Drive Type

The drive type controls the way which the autopilot drives the steering system. The default setting should be retained for mechanically driven vessels.

---

Range:	1 = Mechanically driven vessels without a rudder reference unit 2 = Hydraulic, no rudder reference unit 3 = Linear, rotary and sterndrive with a rudder reference unit 4 = Hydraulic with rudder reference unit
--------	--

---

<b>Default:</b>	for Pilot Type Displacement	3
	for Pilot Type Semi-Displacement	4
	for Pilot Type Planing	4
	for Pilot Type Sterndrive	3

---

## Rudder Damping

Set this option only if your system includes a rudder reference unit, and the drive hunts when trying to position the rudder.

Test for this when your vessel is moored dockside, by pressing **AUTO** and then **+10**. If the helm overshoots and has to drive back, or starts to hunt back and forth, increase the damping level.

Alternatively, you can set a value between 1 to 9. Adjust the damping one level at a time, and always use the lowest acceptable value.

---

Range:	1 to 9
--------	--------

---

<b>Default:</b>	2
-----------------	---

---



## Variation

If required, set this value to the level of magnetic variation present at your vessel's current position. The variation setting is sent to other instruments on the SeaTalk system, and can be updated by other SeaTalk instruments.

---

Range: 30° EAST or WEST

---

Default: 0°

---

## AutoAdapt

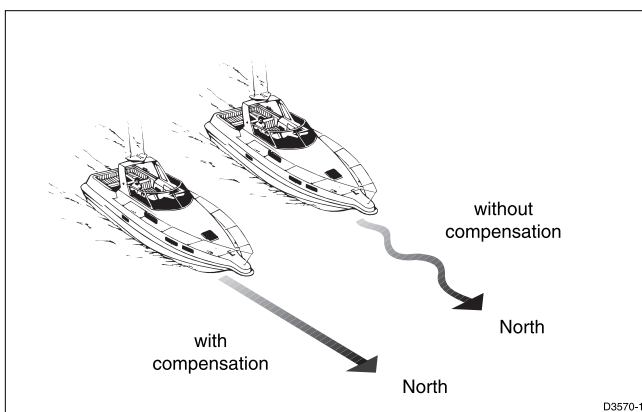

The AutoAdapt feature allows the Course Computer to compensate for heading errors at higher latitudes, which are caused by the increasing dip of the earth's magnetic field. The increased dip has the effect of amplifying rudder response on northerly headings in the northern hemisphere, and on southerly headings in the southern hemisphere.

Set AutoAdapt to nth in the northern hemisphere, or Sth in the southern hemisphere. You then need to enter your current latitude in the next setup screen, so that the Course Computer can provide accurate course-keeping by automatically adjusting the rudder gain depending on the heading.

---

Range: OFF  
nth = North  
Sth = South

---

Default: OFF

---

## Latitude

This screen is only used if AutoAdapt is set to North or South.

Use the up and down arrow keys to set the value to your vessel's current latitude, to the nearest degree.

---

Range: 0° to 80°

---

**Default:** 0°

---

**Note:** *If valid latitude data is available via SeaTalk or NMEA, it will be used instead of this calibration value.*

## Wind Trim

This varies the response of the autopilot when in Wind mode.

---

Range: 1 = Normal setting  
2 = Faster response for wind shifts

---

**Default:** 1

---

## AutoRelease

AutoRelease provides emergency manual override, should it be necessary, to avoid an obstacle at the last moment. This option only applies to cable-operated sterndrive actuators – for all other systems this option should be set to off.

---

Range: OFF  
On

---

**Default:** for Pilot Type Displacement OFF  
for Pilot Type Semi-Displacement OFF  
for Pilot Type Planing OFF  
for Pilot Type Sterndrive On

---

## Response

This is the power-on response setting. The response level can be changed during normal operation (see *Section 3.3*).

---

Range: 1 = Auto Seastate  
2 = Auto sea state inhibit  
3 = Auto sea state inhibit with counter rudder

---

**Default:** 1

---

## Recording Calibration Settings

Having fine-tuned the calibration settings during initial sea trials, record them in the following table for future reference.

<b>Feature</b>	<b>Setting</b>
Pilot Type	
Calibration Lock	
Rudder gain	
Response	
Turn rate Limit	
Rudder Offset	
Off Course Alarm	
AutoTrim	
Drive Type	
Variation	
AutoAdapt	
Latitude	
Rudder Damping	
AutoRelease	
Cruise Speed	
Power Speed	
Rudder Limit	
Rate Level	

## 4.3 Setting Up For ST60 and ST80 Remote Control

Where the ST7000 Plus is used in conjunction with ST60 or ST80 instrumentation, the ST7000 Plus can be used to control the ST60 or ST80 instruments by duplicating the functions of the Remote

Keypads used by these instruments, to allow you to operate your autopilot and ST60/ST80 instruments from the same location.

## Instrument Grouping

Control of ST60 and ST80 instruments is achieved by allocating groups of instruments to Remote Control Keypads (in this case, the ST7000 Plus is used as one such keypad). The ST7000 Plus uses INST REM and MAXI REM Data Pages, to control standard (110 mm) and Maxiview instrument groups, respectively. Each ST7000 Plus can control one group of up to eight ST60 or ST80 standard instruments and another group of up to eight ST80 Maxiview instruments.

Before an ST7000 Plus can be used to remotely control other instruments, you must first define the instrument grouping and then allocate the ST7000 Plus to the required group.

## Setting Up Groups

Grouping allows you to create up to eight standard instrument and eight Maxiview instrument groups:

- Each group can have up to eight instruments.
- Each group must have one or more Remote Keypads or an ST7000 Plus grouped to it.
- Each ST7000 Plus can be grouped with one Maxiview group and one standard instrument group.
- Each instrument in a group has a unique alphanumeric identity (e.g. A1, where A defines the group and 1 the instrument sequence number within the group). Standard ST60 or ST80 instruments are assigned group letters from A to H. Maxiview instruments are assigned group letters from J to Q. Ungrouped instruments have a dash (-) in place of a group letter.
- The instrument sequence number range is from 1 to 8.

For the purposes of conciseness, the ST7000 Plus keys used to control groups of ST60 or ST80 instruments are referred to in this handbook as the *instrument group keys*. The instrument group keys are:

- For standard instruments, **resp, track, set crs, res'm**, down arrow and up arrow.
- For Maxiview instruments, **resp, track**, down arrow and up arrow.

## Grouping Standard Instruments

The instrument group key functions for setting up ST60 and ST80 standard instrument groups are shown in the following illustration.

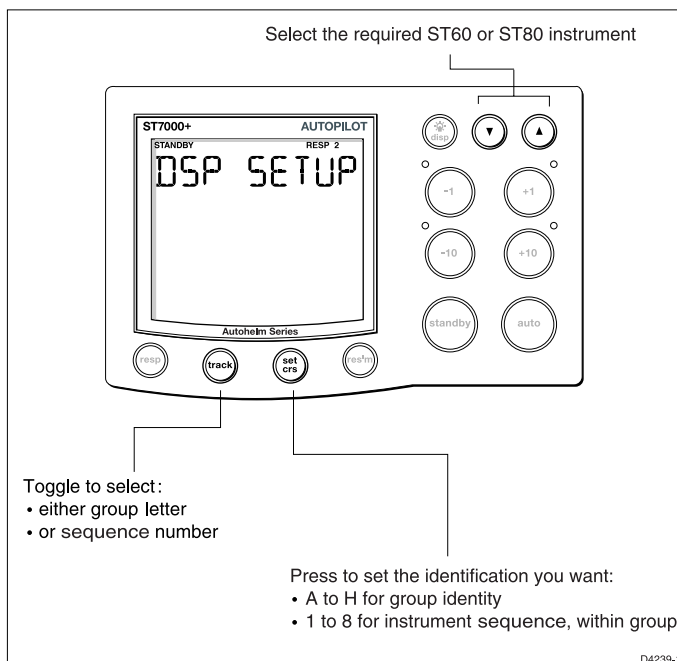

When setting up an instrument group, you need to understand the indications which show when an instrument is selected. This depends on instrument type as follows:

- On selected ST80 instruments, the characters are displayed in inverse video (i.e. white characters on a black background).
- On selected ST60 digital instruments, a REMOTE legend is displayed.
- On selected ST60 analogue instruments, either one or both of the TRUE/MAG or TRUE/APP annunciators flash on the digital display.

To set up a standard instrument group:

1. At the ST7000 Plus, select the INST REM Data Page.
2. Press one of the instrument group keys so that one of the ST60 or ST80 instruments is selected.
3. Hold down the up and down arrow keys for 4 seconds, to put all

the standard instruments and the ST7000 Plus into group setup mode. When this occurs, one standard instrument is selected with a flashing cursor, and the ST7000 Plus screen text will alternate between INST REM and DSP SETUP.

4. At the ST7000 Plus, use the up arrow or down arrow key to select an instrument to be the first in the group.

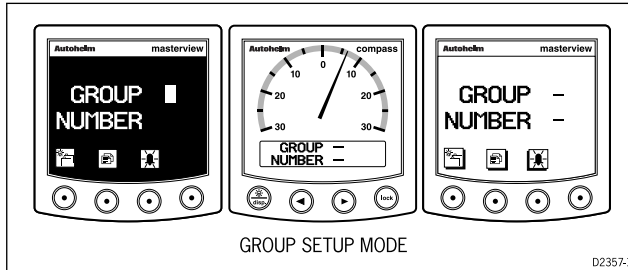

5. Use the ST7000 Plus to allocate a group letter and sequence number to the selected instrument. To do this, use the **track** key to toggle between group letter and sequence number, and the **set crs** key to set the identifying character. When the instrument has been properly identified it should display its group letter and sequence number, e.g. A2.

**Note:** All standard instruments are selectable while in group setup mode.

6. Press either the up arrow or down arrow key to select another instrument and repeat the procedure in step 5.
7. Repeat the procedures in steps 5. and 6. until all instruments in the group have been identified.

**Note:** If you have more than eight ST60 or ST80 instruments, a second group, operated by another remote keypad, must be created. The identification code for additional keypads and display heads would be for example, B1, B2 etc.

8. Use the arrow keys to select one of the ST60 or ST80 instruments in the group to which you want to allocate the ST7000 Plus as a keypad.
9. Hold down the up and down arrow keys together for 1 second. The ST7000 Plus screen text will alternate between INST REM and KPD SETUP, and each of the instruments in the selected group will display prompt messages similar to the following.



10. Press one of the instrument group keys on the ST7000 Plus to allocate it to the selected group of instruments.
11. If you are creating more than one group, repeat the procedures described in actions 3 to 10.
12. When all instrument groups have been set up, hold down the **track** and **set crs** keys for 1 second, to return to group setup mode.
13. Hold down the **track** and **set crs** keys for 2 seconds, to return to normal operation.

## Grouping Maxiview Instruments

The instrument group key functions for setting up Maxiview instrument groups are as follows:

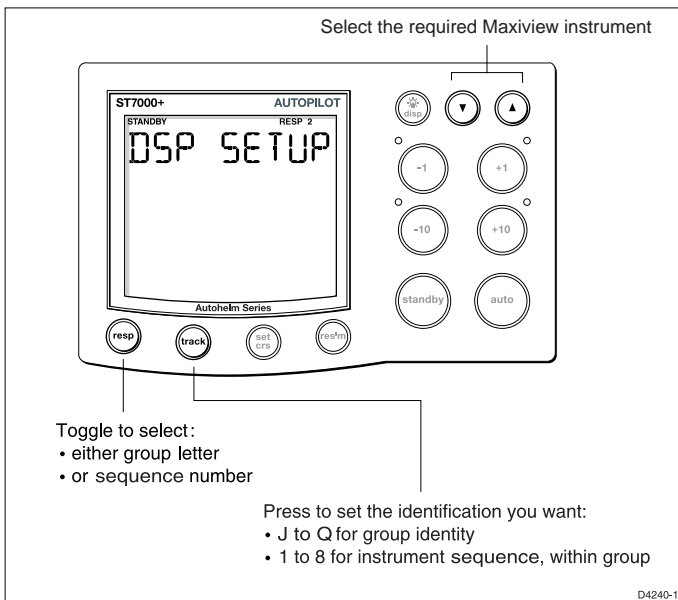

To set up a Maxiview instrument group:

1. At the ST7000 Plus, select the MAXI REM Data Page.
2. Press one of the instrument group keys so that one of the Maxiview instruments is selected (indicated by inverse display characters on the selected instrument).
3. Hold down the up and down arrow keys for 4 seconds, to put all the Maxiview instruments and the ST7000 Plus into group setup mode. When this occurs, one Maxiview instrument displays reverse video with a flashing cursor, and the ST7000 Plus screen text will alternate between MAXI REM and DSP SETUP.
4. At the ST7000 Plus, use the up arrow or down arrow key to select an instrument to be the first in the group, i.e. so the required instrument changes to inverse video.
5. Use the ST7000 Plus to allocate a group letter and sequence number to the selected Maxiview. To do this, use the **resp** key to toggle between group letter and sequence number, and the **track** key to set the identifying character. When the Maxiview instrument has been properly identified it should display its group letter and sequence number, e.g. J2.

**Note:** *All Maxiview instruments are selectable while in group setup mode.*

6. Press either the up arrow or down arrow key to select another Maxiview instrument, and repeat the procedure in step 5.
7. Repeat the procedures in steps 5. and 6. until all instruments in the group have been identified.

**Note:** *If you have more than eight Maxiview instruments, a second group, operated by another remote keypad, must be created. The identification code for additional keypads and display heads would be for example, K1, K2 etc.*

8. Use the arrow keys to select one of the Maxiview instruments in the group to which you want to allocate the ST7000 Plus as a keypad.
9. Hold down the up and down arrow keys together for 1 second. The ST7000 Plus screen text will alternate between MAXI REM and KPD SETUP, and each of the Maxiview instruments in the selected group will display prompt messages similar to those for the standard instrument.



10. Press one of the instrument group keys on the ST7000 Plus to allocate it to the selected group of display heads.
11. If you are creating more than one group, repeat the procedures described in actions 3 to 10.
12. When all instrument groups have been set up, hold down the **resp** and **track** keys for 1 second, to return to group setup mode.
13. Hold down the **resp** and **track** keys for 2 seconds, to return to normal operation.

# Chapter 5: Installation

## 5.1 Planning the Installation

This chapter explains how to install and connect the ST7000 Plus autopilot control unit. Before starting the installation, decide how you will site the unit and run the cables.

### EMC Installation Guidelines

The design and manufacture of Raytheon equipment and accessories conforms to the appropriate Electromagnetic Compatibility (EMC) standards, but good installation is required to ensure that performance is not compromised.

To avoid the risk of operating problems, all Raytheon equipment and cables connected to it should be:

- At least 1 m from any equipment transmitting or cables carrying radio signals e.g. VHF radios, cables and antennas. In the case of SSB radios, the distance should be increased to 2 m.
- More than 2 m from the path of a radar beam. A radar beam can normally be assumed to spread 20° above and below the radiating element.
- The equipment should be supplied from a different battery than the one used for engine start. Voltage drops below 10 V in the power supply to our products can cause the equipment to reset. This will not damage the equipment, but will cause the loss of some information and can change the operating mode.
- Genuine Raytheon cables should be used at all times. Cutting and rejoining these cables can compromise EMC performance and so should be avoided unless called for in the installation manual.
- If a suppression ferrite is attached to a cable, this ferrite should not be removed. If the ferrite has to be removed to facilitate installation it must be reassembled in the same position.

If your Raytheon equipment is going to be connected to other equipment using a cable not supplied by Raytheon, a suppression ferrite **MUST** always be fitted to the cable close to the Raytheon unit.

The following illustration shows the range of suppression ferrites fitted to Raytheon equipment.

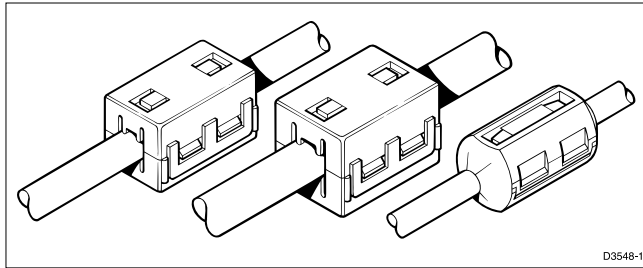

D3548-1

## Cabling

- Avoid running cables through bilges where possible.
- Secure coiled lengths at regular intervals.
- Avoid running cables close to fluorescent lights, engines, radio transmitting equipment etc.

## 5.2 Instrument

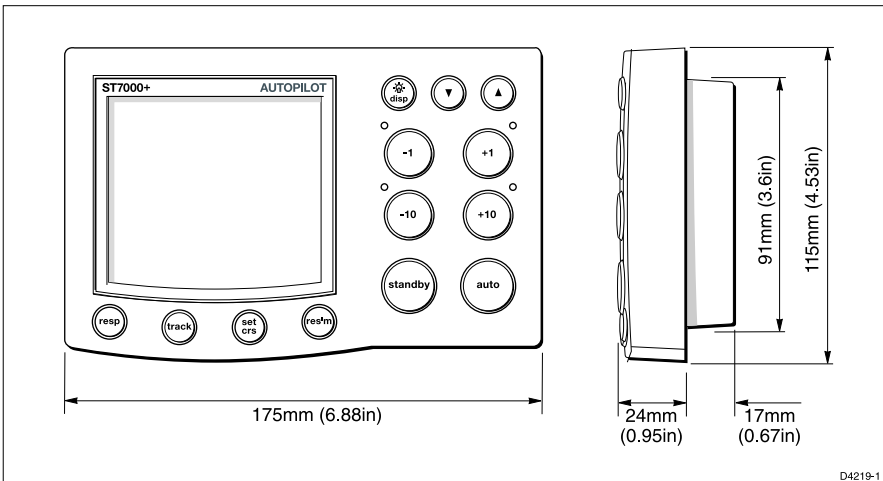

D4219-1

## Siting

### CAUTION

The instrument must be installed so that the rear case is protected from water. The presence of moisture could cause damage either by entering the instrument through the breathing hole or by coming into contact with the electrical connectors at the rear.

The instrument can be installed either above or below deck, provided the rear of the instrument is sited where it is protected from contact with water.

The instrument must also be positioned where it is:

- Within easy reach of the steering position.
- Protected from physical damage.
- At least 230 mm from any compass.
- At least 500 mm from any radio/radar receiving/transmitting equipment.

## Mounting Procedure

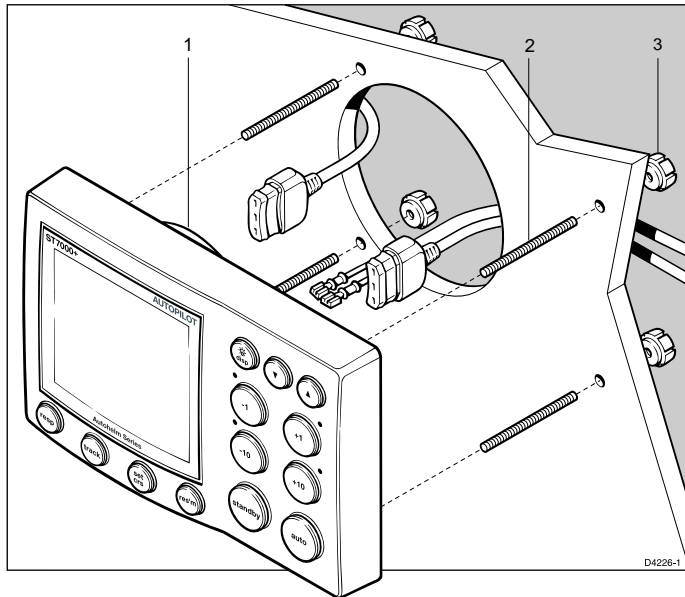

1 Cable boss 2 Fixing studs 3 Thumb nuts

**Note:** Always leave a 6 mm gap between adjacent display heads to allow the protective sun covers to be fitted.

1. Use the template provided (after the *Index* in this handbook) to mark the hole centres for the fixing stud and the cable boss.
2. Drill four 5 mm diameter holes for the fixing studs.
3. **Taking great care not to cut the hole for the cable boss too big,** use a 90 mm diameter cutter to drill the hole for the cable boss (1).

4. Screw the fixing studs (2) into the display head.
5. Pass the cables (SeaTalk, NMEA) through the bulkhead.
6. Fit the cables to the appropriate terminals (see relevant subsection for connection details of each item).
7. Fit the display head to the bulkhead.
8. Assemble the thumb nuts (3) onto the fixing studs (2).
9. Tighten the thumb nuts by hand until the display head is secure.  
**Under no circumstances must a wrench be used to tighten the thumb nuts.**

## Power

Power to the ST7000 Plus should be supplied by the associated autopilot, in accordance with the instructions in the relevant autopilot handbook.

## Connections to the SeaTalk Bus

### SeaTalk Cables

The ST7000 Plus is supplied with a 9 m SeaTalk cable as standard. The following table lists other cables available from your dealer:

<b>Part No:</b>	<b>Type</b>	<b>Length</b>
D187	Flat to a male round connector	0.15 m
D188	Flat to a female round connector	0.3 m
D284	Flat moulded plugs at both ends	1 m
D285	Flat moulded plugs at both ends	3 m
D286	Flat moulded plugs at both ends	6 m
D287	Flat moulded plugs at both ends	9 m

### Cable Types

The following illustration shows the different types of SeaTalk cables available.

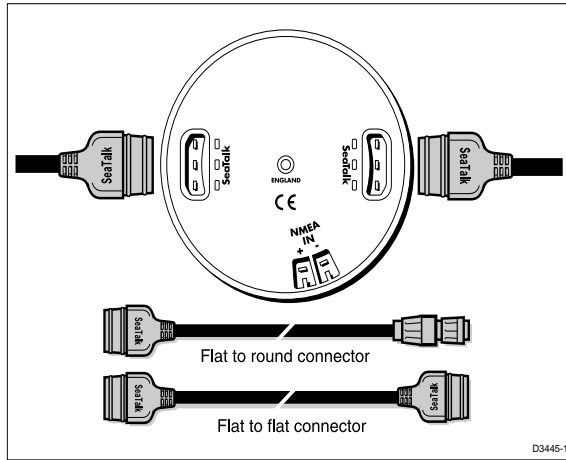

### Typical SeaTalk Cabling

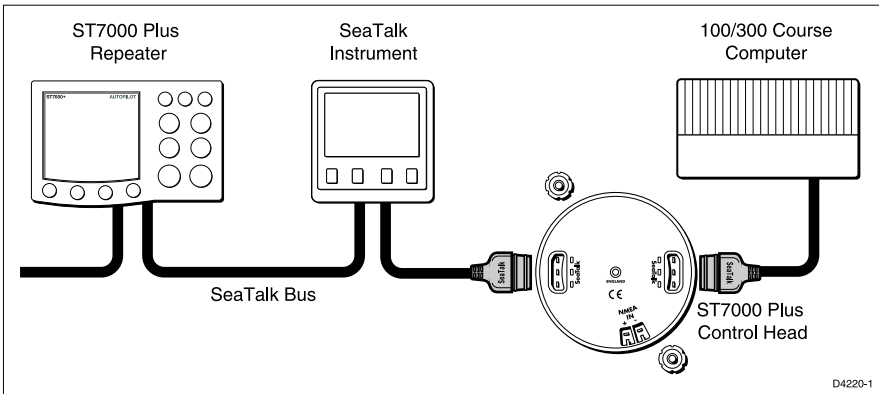

## 5.3 NMEA Interface

ST7000 Plus accepts NMEA navigation data for display and use in Track and Wind modes. The required NMEA data formats are shown in the table at the end of this section.

### Cabling

The NMEA port should be connected to a Navigator or Wind instrument.

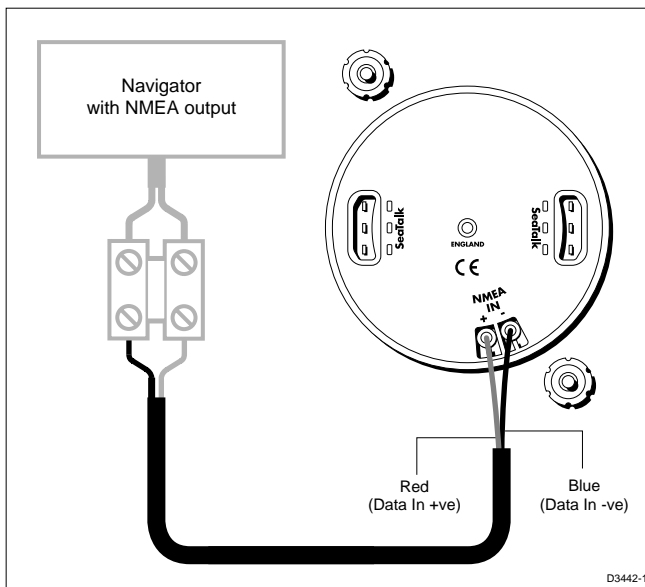

## NMEA Cable Connectors

- NMEA connections are made using spade connectors.
- When fitting the spade connectors, make sure the connector fits securely over the blade and not between the connector and its plastic insulating boot. Incorrectly fitted connectors will give intermittent contact and result in faulty control unit operation.

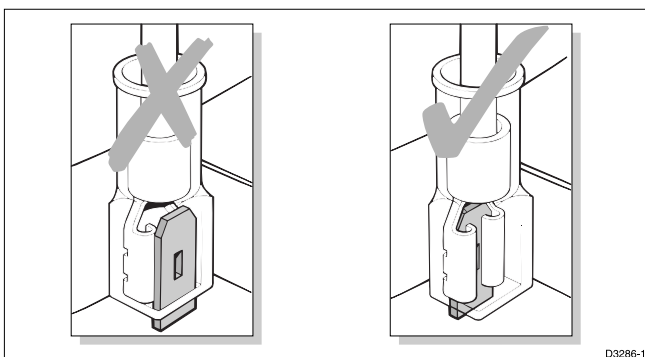

## NMEA Data

The following NMEA 0183 wind and navigation data can be decoded by the ST7000 Plus.

<b>Data</b>	<b>NMEA 0183</b>
Latitude and Longitude	GLL, RMC, RMA, GLP, GOP, GXP, GGA, GDP
Course Over Ground	VTG, RMC, RMA
Speed Over Ground	VTG, RMC, RMA
Cross Track Error	APB, APA, RMB, XTE
Bearing to Waypoint	APB, BWR, BWC, RMB
Distance to Waypoint	BWR, BWC, RMB
Waypoint Number	APB, APA, BWR, BWC, RMB
Apparent Wind Speed	VWR, MWV
Apparent Wind Angle	VWR, MWV
Speed Through Water	VHW
Depth	DBT
Water Temperature	MTW

## Transmission of NMEA Data on SeaTalk

If any of the above NMEA data is received and the equivalent data is not present on SeaTalk, the ST7000 Plus will transmit the data onto SeaTalk to make it available to other SeaTalk compatible instruments.

Depth is transmitted in the units defined by the first depth page in the data page rollover. Water temperature is always transmitted in °C.

If you wish to transmit NMEA information to other equipment a SeaTalk-to-NMEA bridge should be installed.

## 5.4 Functional Test (Repeater Unit)

If you have installed your ST7000 Plus as a repeater unit on an autopilot system, you should perform the functional test described in this section. However, if you have installed the ST7000 Plus as the only control unit for a Type 100/300 course computer, you should now carry out the procedures in *Chapter 6, Post Installation Procedures*.



## Switch On

Having installed your ST7000 Plus, switch on the main power breaker. If the instrument is active and the system is operating, the following will occur:

- The instrument beeps and displays the control unit type, ST7000+.
- After the control unit type has been displayed for 2 seconds, the Standby mode screen should be displayed.

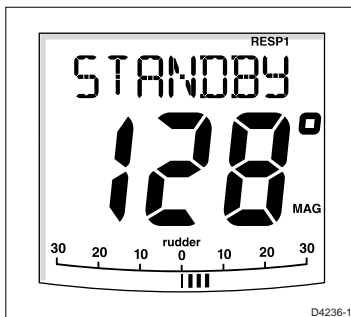

This shows that the control head is active. If the above events do not occur, check the fuse/circuit breaker.

If the text SEATALK FAILURE or NO LINK is displayed, check the SeaTalk cables between the ST7000 Plus control head and the Course Computer.

## Navigation Interface (GPS, Decca, Loran)

If the ST7000 Plus is interfaced to a navigator, via its NMEA data port, the interface can be checked by displaying the default Data Pages. These are XTE, BTW and DTW.

Press **disp** to display the first page, and check that the expected data is displayed. Press **disp** again to check each successive page.

If dashes are displayed instead of data values, the cause could be one or more of the following:

- A cabling error. Check for an open circuit, short circuit or reversed wires.
- The navigator is not configured to transmit the required data format.
- The signals being received by the navigator are too weak for reliable navigation. Refer to the navigator handbook for further action.

## SeaTalk Interface

If the ST7000 Plus has been linked to other instruments via SeaTalk, the link can be checked as follows:

1. Press **standby**.
2. Select display illumination level 3 on any other SeaTalk instrument or autopilot control unit.

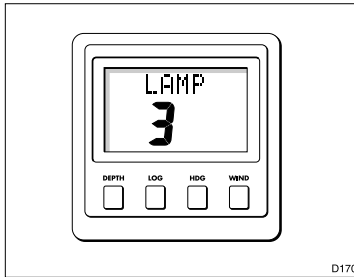

The ST7000 Plus should immediately respond by switching on its display illumination.

If the illumination does not switch on then a cabling fault exists in the SeaTalk cabling between the ST7000 Plus control unit and the instruments/control unit.



# Chapter 6: Post Installation Procedures

This chapter applies to systems where the ST7000 Plus has been installed as the only control unit for a Type 100/300 Course Computer.

Once you have installed the system, you need to confirm that it is wired correctly and is also set up to suit your type of boat.

This chapter provides instructions for the following procedures:

- **Functional test**, consisting of a few simple tests to confirm that the system is wired correctly.
- **Initial sea trial**, to swing the compass and align the heading, check the autopilot's operation and check the rudder gain.

Further customisation can be performed after the sea trial, as described in *Chapter 4*.

## 6.1 Functional Test and Initial Calibration

### Switch On

Having installed your ST7000 Plus system, switch on the main power breaker. If the instrument is active and the system operating, the following will occur:

- The instrument beeps and displays ST7000+.
- If either the Pilot Type has not been set, or compass linearisation or compass alignment have not been carried out, then the display will flash between CALIBRATE and REQUIRED, for approximately 4 seconds, after which time the STANDBY screen is displayed.
- In all other cases, the STANDBY screen is displayed 2 seconds after the ST7000+ screen.

This shows that the instrument is active.

- If the instrument does not beep or the display is blank, check the fuse/circuit breaker.
- If the SEATALK FAILURE or NO LINK alarm is displayed, check the SeaTalk connections.

### Initial Calibration

Set up the correct Pilot Type as described in *Chapter 4*.

## Operating Sense

The operating sense defines the direction the helm will be applied when a course change key is pressed or the vessel goes off course. Check the operating sense as follows:

1. In Standby mode, move the wheel to produce a starboard turn, and check that the rudder angle display moves to the right. If the rudder angle display moves to the left, the red and green wires from the rudder reference transducer must be reversed.
2. Press **auto**.
3. Press the **+10** key. The helm should move to produce a turn to starboard.

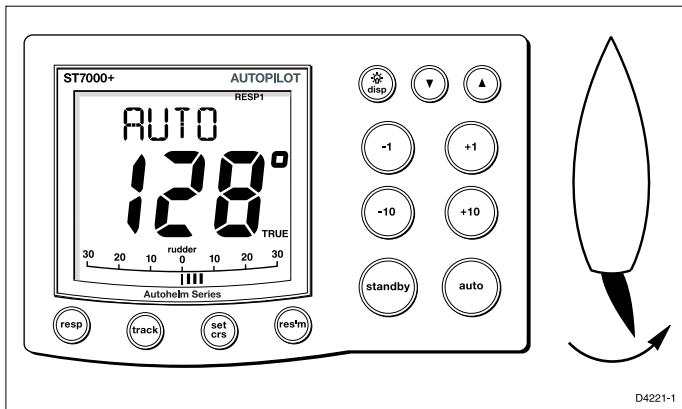

4. If the helm produces a turn to port, reverse the motor connections at the course computer.
5. If the helm overshoots and has to drive back or starts to hunt back and forth, you need to increase the Rudder Damping, described under *Dealer Setup* in *Chapter 4*.

## Navigation Interface (GPS, Decca, Loran)

If the ST7000 Plus is interfaced to a navigator, via its NMEA data port, the interface can be checked by displaying the default Data Pages. These are XTE, BTW, and DTW.

Press **disp** to display the first page, and check that the expected data is displayed. Press **disp** again to check each successive page.

If dashes are displayed instead of data values, the cause could be one or more of the following:

- A cabling error. Check for an open circuit, short circuit or reversed wires.
- The navigator is not configured to transmit the required data format.
- The signals being received by the navigator are too weak for reliable navigation. Refer to the navigator handbook for further action.

## Wind Transducer Interface

If the ST7000 Plus is connected to a wind instrument via its NMEA data port or SeaTalk, then the link between the two instruments should be checked by pressing **standby** and **auto** together.

The ST7000 Plus should display the Wind mode screen, with the locked wind angle and locked heading as shown.

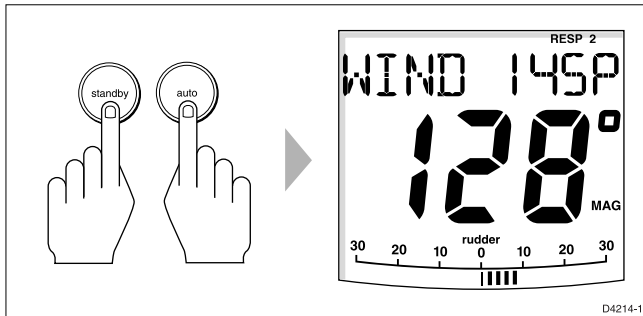

## SeaTalk Interface

If the ST7000 Plus has been linked to other SeaTalk instruments via SeaTalk, the link can be checked as follows:

1. Press **standby**.
2. Select display illumination level 3 on any other SeaTalk instrument or autopilot control unit.

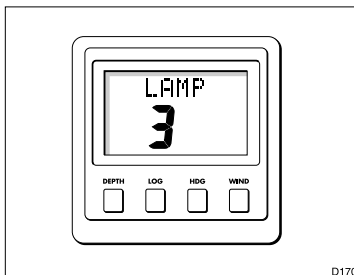

The ST7000 Plus should immediately respond by switching on its display illumination.

If the illumination does not switch on then a cabling fault exists in the SeaTalk cabling between the ST7000 Plus control head and the instruments/control unit.

## EMC Conformance

The design and manufacture of Autohelm equipment and accessories conforms to the appropriate Electromagnetic Compatibility (EMC) standards, but good installation is required to ensure that performance is not compromised. Although every effort has been taken to ensure that they will perform under all conditions, it is important to understand what factors could affect the operation of the product.

Always check the installation before going to sea to make sure that it is not affected by radio transmissions, engine starting etc.

In some installations, it may not be possible to prevent the equipment from being affected by external influences. In general this will not damage the equipment but can lead to it resetting, or momentarily may result in faulty operation.

## 6.2 Initial Sea Trial

Having checked that the system is functioning correctly, a short sea trial is now required to complete the setup. It involves the following procedures:

- Automatic compass deviation correction.
- Heading alignment adjustment.
- Autopilot operation check.
- Rudder gain adjustment.

**Note:** *The ST7000 Plus has a built-in calibration capability which enables the autopilot to be fine tuned to suit the individual vessel, its steering system and dynamic steering characteristics. As supplied from the factory the unit is calibrated to provide safe stable autopilot control for the majority of vessels.*

The initial sea trial should be performed under the following conditions:

- After all the successful completion of the installation procedure, functional testing and initial calibration.

- Before any other changes have been made to the default calibration settings. Check and, if necessary, reset the values to the recommended levels, as described in *Chapter 4*.
- Light wind and calm water, so that autopilot performance can be assessed without the influence of strong winds or large waves.
- In waters clear of any obstructions.

**Note:** *At any time during the sea trial you can press **standby** to return to hand steering.*

## Automatic Compass Deviation Correction

The autopilot will correct the fluxgate compass for most deviating magnetic fields. Compass errors due to deviating magnetic fields can be up to 45°, depending on your vessel type. The correction procedure reduces these to a few degrees, so it is essential to perform the procedure as the first item in your initial sea trial.

### CAUTION

**Failure to carry out the deviation correction may result in impaired autopilot performance on some compass headings.**

To allow the system to determine the deviation and calculate any correction required, you must turn your vessel in slow circles. This procedure must be carried out in calm conditions and preferably in flat water.

To perform the deviation correction:

1. Make sure that the autopilot is in Standby mode.
2. Press and hold the **standby** key for 2 seconds to display the User Setup entry page. If CAL LOCK is displayed, you need to turn off the lock feature contained in Dealer Setup (see *Chapter 4*).

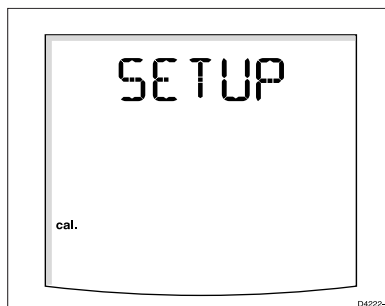



3. Press the **disp** key to move on to the Swing Compass page.

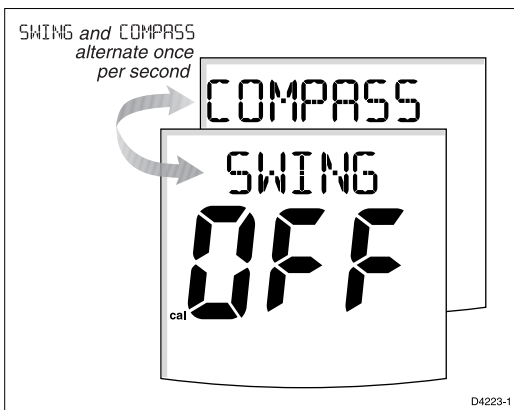

4. Press the **+1** or **-1** key to change the setting from OFF to YES. The Turn Boat page is then displayed.

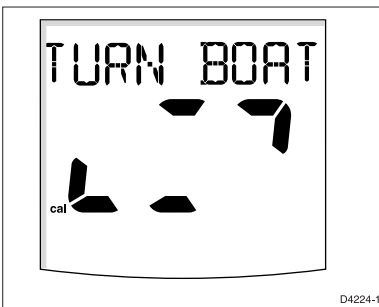

5. Keeping the boat speed below 2 knots, turn the vessel in slow circles. It should take at least 3 minutes to complete 360°.

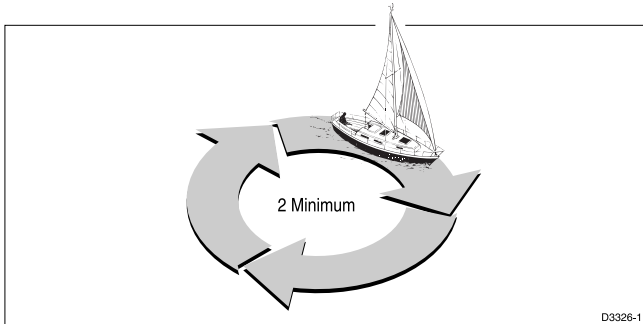

6. Keep turning your boat until the unit beeps and the Deviation screen is displayed.

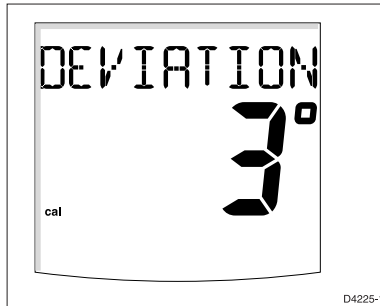

This shows the maximum deviation detected, and indicates that compass correction has been completed successfully.

**Note:** *If the deviation value exceeds 15°, you should consider moving the fluxgate compass to a better location.*

7. Press the **disp** key to move on to the Heading Alignment page.



8. Use the **+1**, **-1**, **+10** and **-10** keys, to adjust the displayed heading, until it agrees with the ship's steering compass or a known transit bearing.

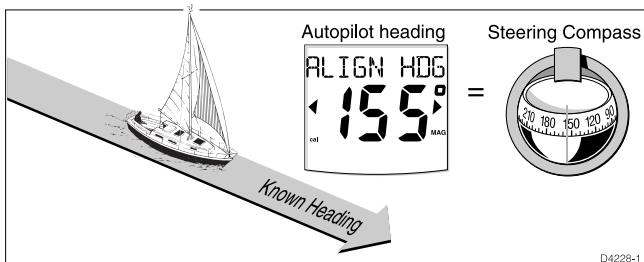

9. Press and hold **standby** for 2 seconds to exit calibration and save the new settings.

**Note:** *Setup options are always saved on exit.*

## Further Heading Alignment Adjustment

You should always check the compass alignment after swinging the compass. However, once the initial deviation correction procedure has been performed, you can make adjustments to the alignment as often as you wish, without swinging the compass again.

Although the compass deviation correction procedure removes most of the alignment error, you will probably be left with a small error (of the order of a few degrees) that will vary depending on the heading.

Ideally, you should check the heading reading against a number of known headings, plot a deviation curve, and determine the heading alignment value that will give the lowest **average** alignment error. This value can then be entered on the Heading Alignment screen, as described above.

If the average heading error is more than  $5^\circ$ , you should perform the compass deviation correction procedure again.

## Checking Autopilot Operation

Having calibrated the compass the following procedure is recommended to familiarise yourself with autopilot operation:

1. Steer onto a compass heading and hold the course steady.
2. Press **auto** to lock onto the current heading. A constant heading should be achieved in calm sea conditions.
3. Use the **-1**, **-10**, **+1** and **+10** keys to alter course to port or starboard in multiples of  $1^\circ$  and  $10^\circ$ .
4. Press **standby** and disengage the autopilot to return to hand steering.

## Checking the Rudder Gain

The factory set rudder gain level will provide stable control for initial sea trials. However, vessels can vary widely in their response to the helm, and further adjustment to the rudder gain may improve the autopilot's steering characteristics.

It is particularly important that the rudder gain is set correctly on high-speed craft. Incorrect adjustment will lead to poor steering performance and is a dangerous condition at high speed.

The following test will determine whether the rudder gain is set too high or too low:

1. In clear water and with the autopilot in Auto, alter course to starboard by  $40^\circ$  by pressing the **+10** key four times.
  - At cruising speeds, course changes of  $40^\circ$  should result in crisp turns followed by an overshoot of no more than  $5^\circ$ . If this occurs the rudder gain is adjusted correctly (as at A below).
  - An excessively high rudder setting results in oversteer. This is recognised by a distinct overshoot of more than  $5^\circ$  (as at B below). This condition can be corrected by reducing the rudder gain setting.
  - Similarly, an insufficient rudder control setting will result in understeer which gives sluggish steering performance (as at C below). If the vessel takes a long time to make the turn and there is no overshoot then the rudder setting is too low.

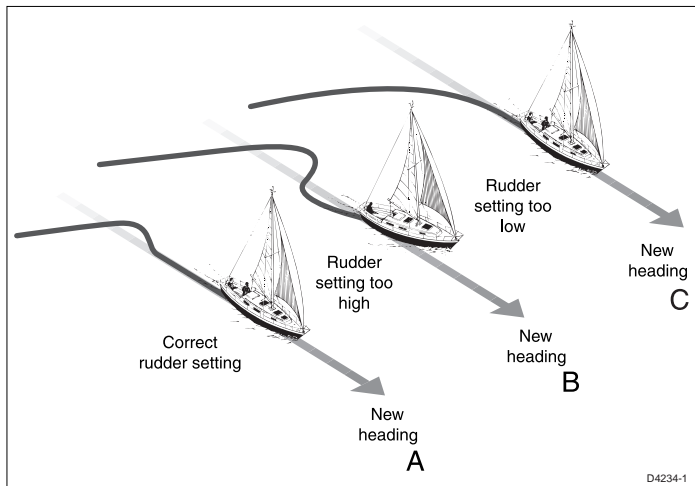

These actions are most easily recognised in calm sea conditions where wave action does not mask basic steering performance.

2. Refer to *Chapter 4, Customising the System*, for instructions on how to adjust the default rudder gain setting. Note that you can also make temporary adjustments to rudder gain during normal operation (see *Adjusting Autopilot Performance* in *Chapter 2*).

3. Repeat the test until a crisp course change with no more 5° of overshoot is achieved.

The rudder control setting should be set to the lowest setting consistent with accurate course keeping. This will minimise helm movements and hence reduce power consumption and wear and tear.

# Chapter 7: Maintenance

## General

- In certain conditions, condensation may appear on the LCD window. This will not harm the unit, and can be cleared by switching on the illumination for a while.
- **Never** use chemical or abrasive materials to clean your ST7000 Plus. If it is dirty, wipe it with a clean, damp cloth.
- Periodically check the cabling for chafing or damage to the outer casing – replace any damaged cables.

## Servicing and Safety

- Autohelm equipment should be serviced only by authorised Autohelm service engineers. They will ensure that service procedures and replacement parts used will not affect performance. There are no user serviceable parts in any Autohelm product.
- Some products generate high voltages, and so never handle the cables/connectors when power is being supplied to the equipment.
- Always report any problem related to Electromagnetic Compatibility (EMC) to your nearest Autohelm dealer. We will use any such information to improve our quality standards.

## Product Support

If any difficulties arise with this product, please contact the Autohelm Product Support department in the UK, or your own national distributor who will be able to provide expert assistance.

The working parts of the drive system are sealed and lubricated for life during manufacture – servicing is not required.

Before you consider returning the instrument, make sure that the power supply cable is sound and that all connections are tight and free from corrosion. If the connections are secure, refer to the Fault Finding chapter of this handbook.

If a fault cannot be traced or rectified, please contact your nearest Autohelm dealer or Service Centre.

Always quote the product serial number, which is printed on the rear cover, and the software version number, which you can see by pressing **standby** for 4 seconds.



# Chapter 8: Fault Finding

All Autohelm products are subjected to a comprehensive test procedure prior to packing and shipping. In the unlikely event that a fault does occur with your autopilot, the following check list should help identify the problem and provide a cure.

## **The autopilot display is blank**

- No power – check the fuse/circuit breaker.

## **The displayed compass heading does not agree with the ships compass**

- The compass has not been corrected for deviation – carry out the deviation and alignment procedures.

## **Vessel turns slowly and takes a long time to come on to course**

- Rudder gain too low.

Vessel overshoots when turning on to a new course

- Rudder gain too high.

## **The autopilot appears to be unstable in Track mode, or track-holding is slow**

- If tide speed exceeds 35% of boat speed, and boat speed is not available via SeaTalk, change the Cruise Speed setting in Dealer Setup to the boat's cruising speed.

## **The autopilot appears to be unstable on Northerly headings in the Northern hemisphere or Southerly headings in the Southern hemisphere**

- Northerly/Southerly heading correction not set up.

## **Display shows CAL LOCK when entering calibration**

- Calibration locked out – calibration protection feature is turned on in Dealer Setup.

## **The autopilot will not talk to other SeaTalk instruments (may be indicated by a SEATALK FAILURE alarm)**

- Cabling problem – make sure all the cables are connected properly.



**Position information not received**

- Navigator not transmitting the correct position data.

**The autopilot will not auto advance to the next waypoint**

- No bearing to waypoint information received from the navigator.

**A series of rotating dashes are displayed on screen**

- Compass deviation correction or dockside rudder calibration is running.

**The display shows a series of stationary dashes**

- Data is not being received – check the cabling.

**The display shows NO DATA**

- The signals received from the navigator are too weak – refer to the navigator handbook for further action.

# Index

## A

### Adjusting

Autopilot performance 28

Locked wind angle 25

Response levels 28

Rudder Gain 29

Advance 22

Advanced Operation 17

Alarms 29

AutoRelease 32

Drive stopped 30

Large XTE 30

Low battery 31

Man overboard (MOB) 33

Next WPT 31

No data 30

No link 29

Off course 30

Route completed 32

SeaTalk failure 29

Shallow 33

Watch 32

Wind shift 30

Auto mode 5

Course changes 10

Dodging obstacles 7

Major course changes 10

AutoAdapt 48

Automatic acquisition 18

Automatic deadband 28

Automatic tack (AutoTack) 9

Automatic track acquisition 18

Autopilot performance adjustment 28

AutoRelease 49

Alarm 32

AutoSeastate 28

AutoTack

In Wind mode 26

To Port 9

To Starboard 9

AutoTrim 46

**B**

- Backlighting 12
- Bar graph 4
- Bar selection 38
- Basic operation 3

**C**

- Cabling 58
  - Checking condition 77
- Calibration lock 43
- Cancelling a dodge manoeuvre 22
- Checking autopilot operation 74
- Checking rudder gain 74
- Cleaning 77
- Compass
  - Alignment 73
  - Deviation correction 71
  - Deviation correction requirement 37
- Condensation 77
- Connections to the SeaTalk bus 60
- Contrast adjustment 13
- Course change keys 6
- Course changes under autopilot control 10
- Cross track error (XTE) 20
- Cruise speed 45, 49
- Customising the autopilot 35–56

**D**

- Data not received 30
- Data Pages 13, 39
  - Setting up 39
- Deadband 28
- Dealer setup 41, 41–56
- Deviation 72
- Deviation display 37
- Display 4
- Display contrast 13
- Dodges 22, 26
- Dodging obstacles
  - Auto mode 7
  - Track mode 22
  - Wind mode 26
- Drive Stopped alarm 30
- Drive type 47

**E**

## EMC

- Conformance xiii, 70

- Installation guidelines 57

- Engaging the autopilot 5

**F**

- Fault finding 79

- Front Panel 3

- Functional test as Repeater Unit 63

**G**

- Graph use 38

**H**

- Hand steering 6

- Heading alignment 37

  - Checking after compass swing 74

- Heading bar 4

- Heading mode 38

**I**

- Initial calibration 67

- Initiating a dodge manoeuvre 22

- Initiating Track mode 17

- Installation 57

- Interfaces 64

**J**

- Joystick control 11

**K**

- Key functions 3

**L**

- Large Cross Track Error 30

  - Alarm 20

- Last heading 8

- Latitude 49

- Locked wind angle 25

- Low battery alarm 31

**M**

- Magnetic variation 48
- Maintenance 77
- Major course changes 10
- Man Overboard (MOB) alarm 33
- Manual acquisition 19
- Manual mode 11
- Manual steering 6
- Manual track acquisition 19
- Minimum deadband 28

**N**

- Navigation data displays 13
- Navigation interface (GPS, Decca, Loran) 64, 68
- NEXT WPT 31
- NMEA
  - Cable Connectors 62
  - Data Transmission 62
  - Interface 61
- No Data alarm 30
- No Link alarm 29

**O**

- Off Course alarm 10, 30, 45
  - clearing 30
- Operating modes 1
- Operating sense 68
- Operation in Wind mode 24

**P**

- Performance 28
- Pilot type 42
- Planning the installation 57
- Plot frequency 23
- Position confirmation at the start of a passage 23
- Post installation procedures 67
- Power requirement 2
- Power steer 46
- Previous apparent wind angle 25
- Previous heading 8
- Product support 77

**R**

- Recommended Settings 42
- Recording calibration settings 50
- Response levels 49
  - Adjusting 28
- Returning to the previous locked heading 8
- Route completed alarm 32
- Rudder bar 38
- Rudder calibration 38
- Rudder damping 47
- Rudder gain 29, 43, 74
- Rudder limit 44

**S**

- Safety xii, 5, 23, 77
- Sea trial 70
- SeaTalk interface 65, 69
  - Data displays 13
  - Failure 29
  - Typical cabling 61
- Servicing 77
- Set Course screen 6
- Setting waypoints 23
- Shallow alarm 33
- Skipping a waypoint 22
- Software version number 41
- ST60 and ST80 instruments
  - Controlling with ST7000 Plus 15
  - Setting up for use with ST7000 Plus 50
- Standby mode 6
- Start up conditions 5
- Steering bar 38
- Swinging the compass 71
- Switch on 67
- System testing 67–76

**T**

- Testing the system 63, 67–76
- Tidal stream compensation 21
- Track acquisition 17
- Track mode 17–18
- Turn limit 44
- Turn rate level 43

**U**

User setup 35

**V**

Variation 48

Verifying computed positions 23

**W**

Warranty xi

Watch alarm 31

Waypoints

Arrival and advance 21

Setting 23

Skipping 22

Waypoint names 14

Wind angle error bar 4

Wind mode 24

Wind shift alarm 26, 30

Wind transducer interface 69

WindTrim 24, 49

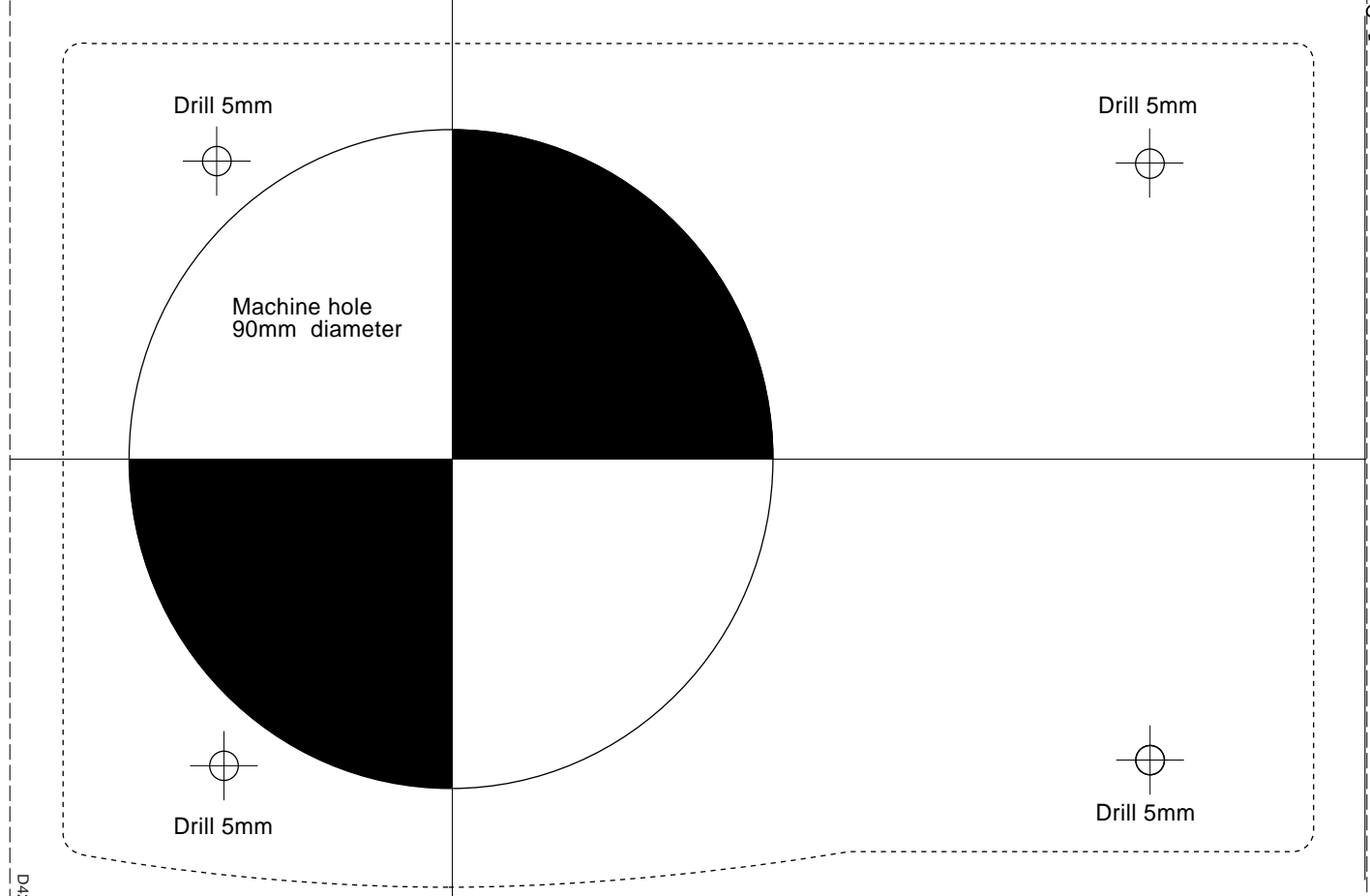



---

# Limited Warranty Certificate

Raytheon Marine Company warrants each new Light Marine/Dealer Distributor Product to be of good materials and workmanship, and will repair or exchange any parts proven to be defective in material and workmanship under normal use for a period of 2 years/24 months from date of sale to end user, except as provided below.

Defects will be corrected by Raytheon Marine Company or an authorized Raytheon dealer. Raytheon Marine Company will, except as provided below, accept labor cost for a period of 2 years/24 months from the date of sale to end user. During this period, except for certain products, travel costs (auto mileage and tolls) up to 100 round trip highway miles and travel time of 2 hours, will be assumed by Raytheon Marine Company only on products where proof of installation or commission by authorised service agents, can be shown.

## Warranty Limitations

Raytheon Marine Company Warranty policy does not apply to equipment which has been subjected to accident, abuse or misuse, shipping damage, alterations, corrosion, incorrect and/or non-authorized service, or equipment on which the serial number has been altered, mutilated or removed.

Except where Raytheon Marine Company or its authorized dealer has performed the installation, it assumes no responsibility for damage incurred during installation.

This Warranty does not cover routine system checkouts or alignment/calibration, unless required by replacement of part(s) in the area being aligned.

A suitable proof of purchase, showing date, place, and serial number must be made available to Raytheon Marine Company or authorized service agent at the time of request for Warranty service.

Consumable items, (such as: Chart paper, lamps, fuses, batteries, styli, stylus/drive belts, radar mixer crystals/diodes, snap-in impeller carriers, impellers, impeller bearings, and impeller shaft) are specifically excluded from this Warranty.

Magnetrons, Cathode Ray Tubes (CRT), hailer horns and transducers are warranted for 1 year/12 months from date of sale. These items must be returned to a Raytheon Marine Company facility.

All costs associated with transducer replacement, other than the cost of the transducer itself, are specifically excluded from this Warranty.

Overtime premium labor portion of services outside of normal working hours is not covered by this Warranty.

Travel cost allowance on certain products with a suggested retail price below \$2500.00 is not authorized. When/or if repairs are necessary, these products must be forwarded to a Raytheon Marine Company facility or an authorized dealer at owner's expense will be returned via surface carrier at no cost to the owner.

Travel costs other than auto mileage, tolls and two (2) hours travel time, are specifically excluded on all products. Travel costs which are excluded from the coverage of this Warranty include but are not limited to: taxi, launch fees, aircraft rental, subsistence, customs, shipping and communication charges etc..

Travel costs, mileage and time, in excess to that allowed must have prior approval in writing.

TO THE EXTENT CONSISTENT WITH STATE AND FEDERAL LAW:

(1) THIS WARRANTY IS STRICTLY LIMITED TO THE TERMS INDICATED HEREIN, AND NO OTHER WARRANTIES OR REMEDIES SHALL BE BINDING ON RAYTHEON MARINE COMPANY INCLUDING WITHOUT LIMITATION ANY WARRANTIES OF MERCHANTABILITY OR FITNESS FOR A PARTICULAR PURPOSE.

(2) Raytheon Marine Company shall not be liable for any incidental, consequential or special (including punitive or multiple) damages.

All Raytheon Marine Company products sold or provided hereunder are merely aids to navigation. It is the responsibility of the user to exercise discretion and proper navigational skill independent of any Raytheon equipment.

**United States of America**

Raytheon Marine Company  
Recreational Products  
676 Island Pond Road  
Manchester, NH 03109-5420  
U.S.A.

Tel 603-647-7530  
Fax 603-634-4756

**UK, Europe, Middle East, Far East**

Raytheon Marine Company  
Recreational Products  
Anchorage Park, Portsmouth  
PO3 5TD, England

Tel (44) 1705 693611  
Fax (44) 1705 694642  
Fax Customer support (44) 1705 661228

---

**Raytheon**  
**Factory Service Centers**

**United States of America**  
Raytheon Marine Company  
Address as above.

**UK, Europe, Middle East, Far East**  
Raytheon Marine Company  
Address as above.



Stick barcode label here

Purchased from \_\_\_\_\_ Purchase date \_\_\_\_\_

Dealer Address \_\_\_\_\_

Installed by \_\_\_\_\_ Installation date \_\_\_\_\_

Commissioned by \_\_\_\_\_

Commissioning date \_\_\_\_\_

Owner's name \_\_\_\_\_

Mailing address \_\_\_\_\_

---

This portion of card should be completed and retained by the owner.

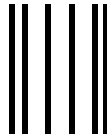

**BUSINESS REPLY MAIL**

FIRST CLASS MAIL PERMIT NO. 369 MANCHESTER NH

POSTAGE WILL BE PAID BY ADDRESSEE

Attn: Warranty Department  
**Raytheon Marine Company**  
 Recreational Products  
 676 Island Pond Road  
 Manchester NH 03109-9953  
 USA

NO POSTAGE  
 NECESSARY  
 IF MAILED  
 IN THE  
 UNITED STATES

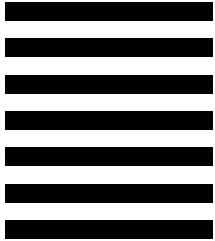

## North and South America

Detach and mail this portion within **48 hours**.

To validate the warranty, the customer or dealer must fill in the requested information below and mail to address shown on front

Retain other portion for your records.

Stick barcode label here

Purchased from

Purchase date

Dealer address

Installed by

Installation date

Commissioned by

Commissioning date

Owner's name

Boat's name/type/location

Mailing address

Owner's occupation



Note: This information is held by Raytheon Marine only and shall not be made available to any other companies. Raytheon Marine may send you mailshots/details of any new products.

Please tick this box  if you do not wish to receive any further information from Raytheon Marine.

2



NO STAMP REQUIRED IF POSTED IN THE UK.

**Raytheon Marine Company**

Recreational Products

Freepost PT 1127

Portsmouth

PO3 5BR

England



## UK, Europe, Middle East and Far East

Detach and mail this portion within **48 hours**.

To validate the warranty, the customer or dealer must fill in the requested information below and mail to address shown on front.

Retain other portion for your records.

Stick barcode label here

Purchased from

Purchase date

Dealer address

Installed by

Installation date

Commissioned by

Commissioning date

Owner's name

Boat's name/type/location

Mailing address

Owner's occupation